



---

# Application of Advanced Grid-scale Inverters in the NEM

---

**August 2021**

White Paper

An Engineering Framework report on design capabilities needed for the future National  
Electricity Market

# Important notice

## PURPOSE

AEMO has prepared this document to provide information about the application of advanced grid-scale inverters and provides recommendations toward enabling this technology to support the future NEM. This paper represents an initial step in exploring advanced inverter technology. Further stakeholder collaboration will be required to develop effective pathways toward the use of this technology in the identified applications. This collaboration will take place as part of the broader Engineering Framework stakeholder engagement.

This publication is generally based on information available to AEMO as at 30 July 2021 unless otherwise indicated.

## DISCLAIMER

This document or the information in it may be subsequently updated or amended. This document does not constitute legal, business, engineering or technical advice. It should not be relied on as a substitute for obtaining detailed advice about the National Electricity Law, the National Electricity Rules, any other applicable laws, procedures or policies or the capability or performance of relevant equipment.

AEMO has made reasonable efforts to ensure the quality of the information in this publication, but cannot guarantee that information, forecasts and assumptions are accurate, complete or appropriate for your circumstances. This publication does not include all of the information that an investor, participant or potential participant in the National Electricity Market might require, and does not amount to a recommendation of any investment. Anyone proposing to use the information in this publication (which includes information and forecasts from third parties) should independently verify its accuracy, completeness and suitability for purpose, and obtain independent and specific advice from appropriate experts.

Accordingly, to the maximum extent permitted by law, AEMO and its officers, employees and consultants involved in the preparation of this document:

- make no representation or warranty, express or implied, as to the currency, accuracy, reliability or completeness of the information in this document; and
- are not liable (whether by reason of negligence or otherwise) for any statements or representations in this document, or any omissions from it, or for any use or reliance on the information in it.

## ACKNOWLEDGEMENTS

- AEMO acknowledges the support, co-operation and contribution of participants in providing data and information used in this publication.

## COPYRIGHT

©2021 Australian Energy Market Operator Limited. The material in this publication may be used in accordance with the [copyright permissions](#) on AEMO's website.

**VERSION CONTROL**

---

<b>Version</b>	<b>Release date</b>	<b>Changes</b>
1.0	4/8/2021	Initial publication

---

# Executive summary

This white paper describes the application of advanced grid-scale inverters in the National Electricity Market (NEM), with a focus on grid-forming inverters. This paper provides recommendations toward enabling the application of this technology to support the NEM as the amount of inverter-based resources (IBR) increases and synchronous generation online reduces.

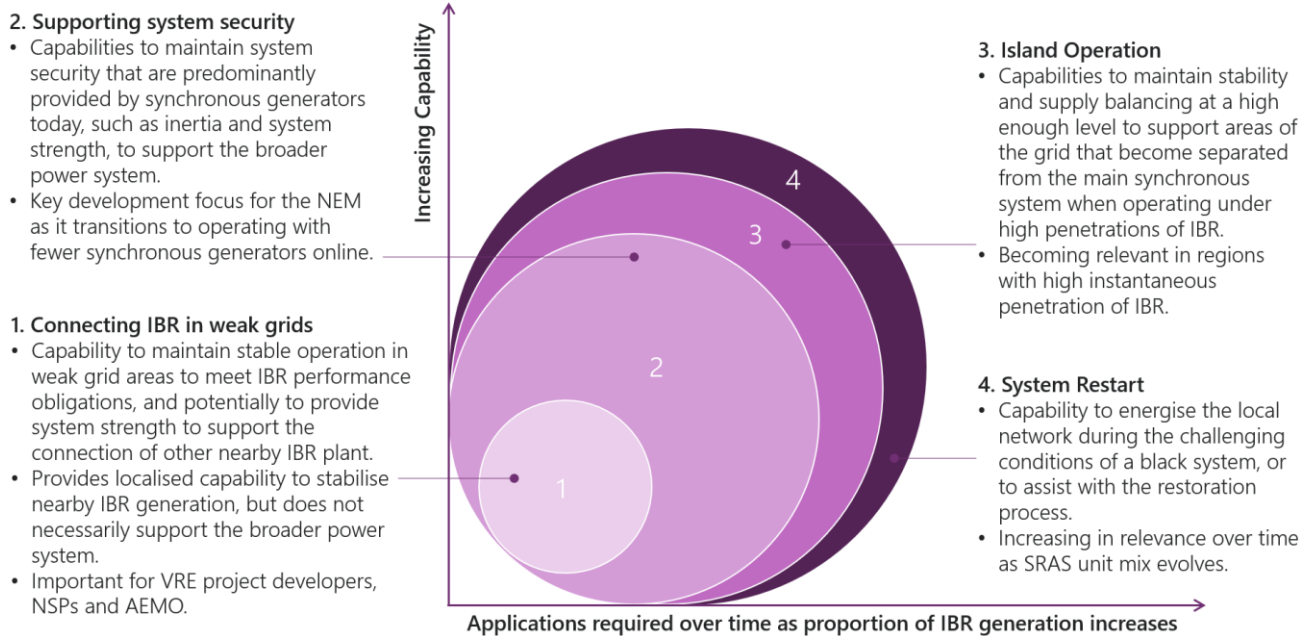
AEMO published a Power System Requirements<sup>1</sup> reference paper in July 2020 which provides clarity on the operability and technical attributes that are critical for secure operation of the power system. While the generation mix in the NEM is changing, the physics that determine its operation remain the same, meaning these attributes will continue to be required during periods of high IBR penetration.

With sufficient attention, focus, and investment, advanced inverter technology may be able to address many of the challenges facing the NEM today for the integration of renewable (inverter-based) resources. However, at present this potential is not demonstrated at the necessary scale, and focused engineering development is urgently needed to address the remaining issues and realise the promise of this technology.

This report takes a capability- and application-led approach to describe the functionality required from advanced inverters. The capabilities required from this technology to support the power system are expected to increase over time as the proportion of synchronous generation online reduces.

Figure 1 describes four applications identified as relevant to advanced grid-scale inverters, in order of increasing capability from lowest to highest. These applications are expected to grow in relevance as technology maturity and system needs evolve.

**Figure 1** Increasing relevance of applications detailed in this paper



The development and deployment of advanced inverter capabilities at scale in the NEM to meet the applications above will require that market bodies, government, and industry prioritise collaboration in four key areas, as detailed further in this report:

<sup>1</sup> See [https://www.aemo.com.au/-/media/Files/Electricity/NEM/Security\\_and\\_Reliability/Power-system-requirements.pdf](https://www.aemo.com.au/-/media/Files/Electricity/NEM/Security_and_Reliability/Power-system-requirements.pdf).

- **Capability specification** – grid connection specifications are needed to provide clear requirements to original equipment manufacturers (OEMs) and developers.
- **Capability demonstration** – maturity of advanced inverter capability varies across the range of necessary power system requirements, with limited deployment and untested performance in large power systems.
- **Costs** – deployment of advanced inverters currently carries a cost premium.
- **Revenue** – many potentially valuable capabilities to support the power system do not have established revenue streams.

The terminology surrounding advanced grid-scale inverters is not yet clearly defined. Broadly, for the purposes of this paper:

- **Grid-following inverters** synchronise to the grid voltage waveform, adjusting their output to track an external voltage reference.
- **Grid-forming inverters** set their own internal voltage waveform reference and can synchronise with the grid or operate independently of other generation.

Grid-forming inverters with a firm energy source behind them may be able to replace many of the capabilities historically provided by synchronous generators. Initially, AEMO recommends prioritising deployment of grid-forming capabilities on grid-scale battery energy storage systems (BESS) as this technology provides capability to deliver firm, flexible energy behind the inverter. While large, standalone BESS provide one way to deliver grid-forming capability, smaller batteries (with storage capability of several minutes) coupled to variable renewable energy (VRE) plant might also provide a flexible resource mix to cater for the applications described in this paper.

With a growing number of grid-scale batteries committed or proposed on the NEM, there is a rare window of opportunity to build grid-forming capabilities into this battery fleet today. This would enable testing and demonstration of these capabilities at scale and begin to build a fleet that can support the power system as it transitions to high IBR penetrations.

Given the speed of transition in the NEM, a balanced approach is needed – one that maximises low-regret opportunities to incorporate grid-forming capabilities on new grid-scale batteries, while proving up the NEM’s ability to rely on varying levels of grid-forming technology for system stabilisation purposes. Further, a cautious approach is needed in the NEM as the technology capability is demonstrated and proven.

Across the sector, time and resources will be needed to prove this technology at scale to support the fastest possible transition and capitalise on grid-forming inverter technology potential. Together, AEMO and industry urgently need to focus in the three areas shown in Figure 2 below to capture the opportunities presented by advanced grid-scale inverters. The top priority should be demonstrating and proving advanced inverter technology capabilities at scale, and maximising the inherent capabilities of all new grid-scale batteries.

In parallel with efforts to accelerate the deployment of advanced inverters, AEMO is working with stakeholders via the Engineering Framework<sup>2</sup> to identify additional priority actions needed to prepare the NEM for operation with fewer synchronous generators online.

---

<sup>2</sup> See <https://aemo.com.au/en/initiatives/major-programs/engineering-framework>.

Figure 2 Recommendations for immediate action



### Enable connection of grid-forming projects

To enable testing and demonstration of grid-forming projects at scale, a pathway is needed to enable secure and timely connection of projects.

#### Recommended Action

AEMO to review the treatment of grid-forming inverter projects in the connections process to establish whether any National Electricity Rules (NER), technical performance specifications or procedure changes are needed to enable their efficient integration.



### Define necessary capabilities

An absence of clear specifications makes it challenging for developers to specify their requirements from OEMs, and for OEMs to design their inverter offerings.

#### Recommended Action

AEMO to investigate how to best define a voluntary grid-forming inverter specification to assist OEMs and developers in delivering solutions to meet power system requirements.



### Enable capabilities on new grid-scale batteries

There is a window of opportunity to build a fleet of grid-forming inverters on currently proposed projects. However, grid-forming carries cost and risk for the project developer.

#### Recommended Action

Further funding and support is needed to assist new grid-scale battery deployments to incorporate grid-forming technology, to build a fleet that can support the transition to high IBR penetration by 2025.

# Contents

<b>Executive summary</b>	<b>4</b>
<b>1. Introduction</b>	<b>9</b>
1.1 Purpose and scope	9
1.2 Approach	10
<b>2. Background</b>	<b>11</b>
2.1 Change is ongoing and undeniable	11
2.2 Requirements of a large AC power system	12
2.3 Defining advanced inverters	14
2.4 The grid-forming inverter system	14
2.5 Performance comparison of advanced inverters	15
<b>3. Applications of advanced inverters</b>	<b>16</b>
3.1 Connecting IBR in 'weak' grid areas	17
3.2 Supporting system security	19
3.3 Island operation	20
3.4 System restart	22
<b>4. Barriers and enablers</b>	<b>23</b>
4.1 Capability specification	24
4.2 Capability demonstration	25
4.3 Cost of this capability	26
4.4 Revenue streams for this capability	27
<b>5. Recommendations and next steps</b>	<b>28</b>
5.1 Recommendations	29
5.2 Next steps	29
<b>Acronyms</b>	<b>31</b>
<b>A1. Case studies</b>	<b>32</b>
A1.1 Case Study 1: grid-forming BESS in West Murray region	32
A1.2 Case Study 2: grid-forming BESS in Queensland network	33
A1.3 Case study 3: ESCRI battery in grid-forming mode	36
A1.4 Case study 4: Wind farm in grid-forming mode	37
A1.5 Case study 5: HVDC station in grid-forming mode	38

# Tables

Table 1	Power system capabilities relevant to advanced inverters	13
Table 2	Performance comparison of grid-connected generation	15
Table 3	Applications identified as relevant to advanced grid-scale inverters	16
Table 4	Key barriers and possible enablers for uptake of advanced grid-scale inverters	24
Table 5	Maturity of advanced inverter applications in large-scale power system	25
Table 6	Cost influences on grid-forming inverter projects	27

# Figures

Figure 1	Increasing relevance of applications detailed in this paper	4
Figure 2	Recommendations for immediate action	6
Figure 3	Penetration of wind and solar generation in the NEM	12
Figure 4	Broad categories of inverters	14
Figure 5	Capabilities required for advanced grid-scale inverter applications	17
Figure 6	Increasing relevance of applications detailed in this paper	28
Figure 7	Recommendations for immediate action	29
Figure 8	Engineering Framework (EF) timeline	30
Figure 9	West Murray region network layout	33
Figure 10	Post disturbance voltage oscillations for the evaluated three cases	33
Figure 11	Single line diagram of Powerlink case study network	34
Figure 12	Base Case voltage oscillations at each bus post-fault	34
Figure 13	Case 2 (with synchronous condenser) voltage oscillations at each bus post-fault	35
Figure 14	Case 3 (with properly tuned grid forming inverter) voltage oscillations at each bus post-fault	35
Figure 15	ESCR1 battery network location – a simple network diagram	36
Figure 16	Active power and rotor speed diagrams in response to a major RoCoF event	38
Figure 17	Simplified network diagram of black starting a hydro generator with HVDC	39
Figure 18	Phasor diagram of the HVDC soft energisation current over 0.5 seconds	39



# 1. Introduction

This white paper describes the application of advanced grid-scale inverters in the National Electricity Market (NEM), with a focus on grid-forming inverters.

The paper provides recommendations toward enabling this technology to support the future NEM as the amount of inverter-based resources (IBR) increases and synchronous generation online reduces.

The power system is undergoing major transformation, with new sources of energy, emerging technologies, and changing consumer behaviour. As the generation mix in the NEM shifts away from synchronous machines toward IBR, the technologies and processes that maintain its stable operation also need to evolve.

AEMO's Renewable Integration Study (RIS)<sup>3</sup> highlighted the challenges of maintaining power system security at very high instantaneous penetrations of IBR, and defined requirements that need to be met to enable operation under these conditions. Building on the RIS, AEMO's Engineering Framework<sup>4</sup> seeks to go beyond renewable integration alone, taking a broader perspective and acknowledging the various activities already happening across industry.

AEMO is now progressing many of the actions identified by the RIS as part of the Engineering Framework, including the optimisation of emerging technologies such as advanced inverters. Recommendations to capture the opportunities presented by advanced grid-scale inverters are identified in this paper in Section 5 and will be progressed under the Engineering Framework.

With sufficient urgent attention, focus, and investment, advanced inverter technology should be able to address many of the challenges facing the NEM today for the integration of renewable (inverter-based) resources. At present this potential is not proven at the necessary scale to allow advanced inverters to be relied on as a provider of system stabilisation, and focused engineering development is urgently needed to address the remaining issues and realise the promise of this technology.

Appropriately sized grid-forming inverters at strategic sites in the NEM have the potential to reduce the system's reliance on synchronous plant, enabling further decarbonisation and delivering benefits to consumers. The inverters that interface IBR generation with the grid can include advanced functionality to support power system operation, and have the potential to provide some of the stability capability that has previously been delivered by synchronous generators.

AEMO sees advanced inverter technology as a key enabler of the future power system and it is imperative that its potential capability be realised to support the system as it transitions to lower levels of synchronous generation online.

## 1.1 Purpose and scope

This white paper identifies the capabilities that advanced inverters could deliver to support management of the power system with fewer synchronous generating units online.

By highlighting the value and potential of advanced inverters, AEMO seeks to:

- Provide information on the opportunity these new technologies create for the NEM, and the barriers that need to be overcome to realise their potential, to assist policy-makers, market bodies, and funding bodies.

---

<sup>3</sup> See <https://aemo.com.au/-/media/files/major-publications/ris/>.

<sup>4</sup> See <https://aemo.com.au/en/initiatives/major-programs/engineering-framework>.

- Provide increased clarity on the capabilities that are needed from advanced inverters in the NEM, to assist developers, manufacturers, and investors when considering new generation and storage developments.
- Summarise the current technology status of advanced inverters and their application in Australia to guide further research, development, and trials, and to highlight where urgent action is needed to realise the potential for the NEM.
- Make recommendations for actionable steps to begin capturing the opportunities presented by advanced grid-scale inverters (see Section 5).

This white paper is focused on the application of advanced capability from grid-scale inverters in the NEM:

- Grid-scale inverters are notionally considered as those installed as part of a generation connection point with a rated capacity of 5 megawatts (MW) or above. This does not exclude the potential of smaller distributed energy resources (DER) to provide capabilities in line with the applications discussed in this paper, however the readiness of grid-scale inverters is more closely aligned with the urgency of the need to manage the power system with fewer synchronous generating units online.
- This paper focuses on the inherent characteristics and control system performance of inverters rather than their remote management over dispatch timeframes.
- Primarily, this paper covers capabilities provided by grid-forming inverters (as defined in Section 2.3). Other inverter technologies may have the potential to provide similar or a subset of these capabilities; this report does not seek to restrict this potential, but stakeholder feedback reflects the alignment of industry on grid-forming technology and its suitability for supporting the power system.

## 1.2 Approach

This paper describes the current status and development pathways for grid-forming inverter technology.

This information has been gathered by AEMO through a broad range of stakeholder interviews, international perspectives, and collaborations, and a review of available literature.

To inform this paper, AEMO conducted stakeholder interviews with a cross-section of industry between September and December 2020. This consisted of original equipment manufacturers (OEMs), developers, international research organisations, international system operators, and regulated bodies. In these interviews, AEMO sought to understand some of the key questions surrounding grid-forming inverter technology, including:

- What is grid forming?
- What can grid-forming inverters be used for?
- What are the key enablers or barriers to grid forming in the NEM?
- How can grid-forming inverters be used to enable the transition to a renewable low-emissions future, with high penetration of IBR and low levels of synchronous (rotating) machines?

AEMO also reviewed the latest research, publications, and trials, and collaborated internationally with other power system operators and organisations to share knowledge and insights that informed this paper. The aim was to identify key focus areas for advanced inverter technology and its potential application in the NEM, rather than providing a comprehensive review of all available literature.

This paper represents an initial step in exploring advanced inverter technology. Further industry collaboration will be required to develop effective pathways toward the use of this technology in the applications covered in Section 3. This collaboration will take place as part of the broader Engineering Framework stakeholder engagement.

# 2. Background

The NEM is transforming fast, with increasing reliance on IBR and reduction in synchronous generation. This trend is presenting new challenges and opportunities for secure system operation.

Advanced grid-scale inverters might be able to support power system security during this transition, potentially even delivering the majority of support capabilities in a future system with low levels of synchronous generation online – but only if Australia puts the right focus on developing and proving them at scale.

## 2.1 Change is ongoing and undeniable

Historically, supply of electricity in the NEM and worldwide was dominated by large, centralised synchronous generators (including coal, gas, and hydro). The design decisions that led to today's power system in the regional power systems that comprise the NEM were based on the capabilities provided by synchronous generation, and the design of the NEM reflected this fundamental engineering design.

The NEM has seen transformational change in its generation mix for many years. IBR such as wind and solar generation are being deployed at a scale and pace not seen anywhere else in the world and are influencing the operation of the synchronous generation fleet. Some regions of the NEM are leading the world in demonstrating operation of a gigawatt-scale power system with low levels of synchronous generation. South Australia and Tasmania have operated for periods with 93% and 82% IBR generation (wind and solar as a proportion of local generation)<sup>5</sup>.

Increasing IBR generation is resulting in lower levels of commitment of synchronous generation – the very equipment that the power system has been designed around. When offline or decommissioned, these synchronous units can no longer provide the critical system stability capabilities on which the grid relies, requiring that these capabilities be provided by alternative sources.

Further, over time, aging synchronous generation units will retire and AEMO's Integrated System Plan (ISP)<sup>6</sup> projects that these will be replaced with generation predominantly provided by IBR.

The RIS highlighted the potential for the maximum penetration of IBR to increase to over 75% in the Central scenario and 100% in the Step Change scenario in 2025.

Figure 3 shows the penetration of wind and solar generation in the NEM for all dispatch intervals from March 2018 to April 2021. Notably, AEMO's Inputs, Assumptions and Scenarios Report (IASR)<sup>7</sup> has demonstrated that variable renewable energy (VRE) and distributed photovoltaics (DPV) are currently tracking to levels more aligned with the 2020 ISP's Step Change scenario, showing that the pace of transformation is not slowing and, if anything, is increasing.

Synchronous condensers are currently being deployed to provide system strength and inertia in weak grid areas as IBR penetration levels rise. This includes installation by transmission network service providers (TNSPs) to address identified system strength shortfalls, and by developers of new IBR generation plants to support the requirements of their network connection. This reflects the immediacy of the design challenge to maintain system stability during periods when few synchronous generating units are online, and raises the

---

<sup>5</sup> Wind and solar generation made up 93% of South Australia's local generation on 4 July 2018. In Tasmania, 82% was reached on 16 January 2021.

<sup>6</sup> See <https://aemo.com.au/en/energy-systems/major-publications/integrated-system-plan-isp/2020-integrated-system-plan-isp>.

<sup>7</sup> See <https://aemo.com.au/consultations/current-and-closed-consultations/2021-planning-and-forecasting-consultation-on-inputs-assumptions-and-scenarios>.

question of whether advanced inverters might be able to support system stability themselves without the need for additional synchronous equipment.

**Figure 3 Penetration of wind and solar generation in the NEM**



Source: AEMO data<sup>8</sup>.

## 2.2 Requirements of a large AC power system

AEMO published a Power System Requirements<sup>9</sup> reference paper in July 2020 which provides clarity on the operability and technical attributes that are critical for secure operation of the power system. While the generation mix in the NEM is changing, the physics that determine its operation remain the same, meaning these attributes will continue to be required during periods of high IBR penetration.

Specifically, the technical attributes identified by the Power System Requirements paper needed from IBR generation include:

- Resource adequacy and capability.
- Frequency management.
- Voltage management.
- System restoration.

These technical attributes can be further broken down into the capabilities that advanced inverters could potentially provide to support the power system under high penetration of IBR, as described in Table 1.

<sup>8</sup> Figure 3 shows the contribution of wind and solar (including both grid-scale and distributed PV) as a proportion of total NEM generation. This does not include the contribution of other renewable technologies such as hydro and biomass.

<sup>9</sup> See [https://www.aemo.com.au/-/media/Files/Electricity/NEM/Security\\_and\\_Reliability/Power-system-requirements.pdf](https://www.aemo.com.au/-/media/Files/Electricity/NEM/Security_and_Reliability/Power-system-requirements.pdf).

**Table 1 Power system capabilities relevant to advanced inverters**

Capability	Description	Purpose
<b>System strength<sup>A</sup></b>	The ability to generate, maintain, and control the voltage waveform.	Support maintaining network synchronism during steady state operation, disturbances, and recovery after disturbances and supply enough fault current to ensure correct operation of network protection systems.
<b>Disturbance withstand</b>	Defined responses and ability to maintain stable operation during voltage, frequency, phase disturbances (fault ride-through), and to damp active power oscillations after a disturbance.	Maintain supply resources operating during and following a disturbance, to support power system recovery and stabilisation.
<b>Inertia<sup>C</sup></b>	Instantaneous and inherent active power response, not dependant on measurement, to rapid changes in frequency.	Impede the system's rate of change of frequency (RoCoF) as a response to frequency disturbances.
<b>Primary frequency response<sup>C</sup></b>	Locally controlled active power response to frequency change. Can include Fast Frequency Response (FFR) <sup>B</sup> .	Maintain the network within a tight frequency band, manage intra-dispatch supply and demand variations, and arrest changes in power system frequency. In some cases, FFR can reduce system inertia requirements.
<b>Support power system island</b>	Manage active power output to support island operation over dispatch timescale.	Provide sufficient energy resources (dispatchability, ramp rate, and secondary frequency response) to maintain supply-demand balance within island boundaries.
<b>Initiate or support system restoration</b>	Bring plant online during system restoration process, including provision of necessary surge current and capability to remain online under adverse conditions.	Provision of SRAS during black start.

A. See <https://aemo.com.au/-/media/files/electricity/nem/system-strength-explained.pdf>.

B. See <https://www.aemc.gov.au/rule-changes/fast-frequency-response-market-ancillary-service>.

C. See box below for detail on provision of inertia and FFR from inverters.

### **Inertia and Fast Frequency Response (FFR)**

- Inertia is an inherent quality of a grid-connected device to reduce rapid changes in power system frequency. Specifically:
  - Physical inertia is provided by the rotating masses of synchronous machines, and is the source for nearly all inertia in the NEM today.
  - Synthetic inertia can be provided by grid-forming inverters to mimic the physical inertial response provided by synchronous machines. During a frequency disturbance, a voltage angle difference occurs between the voltage reference within the grid-forming inverter and the network voltage waveform. This leads to an instantaneous injection or absorption of current by the inverter, without the need for any measurement or controlled response<sup>10</sup>.
- FFR is a deliberate, controlled capability of some grid-connected devices to inject or absorb power in response to measured changes in power system frequency. This measurement and response can occur very rapidly (although not instantaneously), and in some cases can reduce the amount of inertia required to maintain a secure power system<sup>11</sup>.
- FFR and inertia are different capabilities and play roles that are not directly interchangeable. The measurement delay in FFR means it does not inherently slow RoCoF in the same manner as inertia,

<sup>10</sup> See <https://www.electranet.com.au/wp-content/uploads/2021/02/CIGRE48-Grid-Forming-BESS-Case-Study-August-2020.pdf>.

<sup>11</sup> See [https://www.aemo.com.au/-/media/Files/Electricity/NEM/Security\\_and\\_Reliability/System-Security-Market-Frameworks-Review/2018/Inertia\\_Requirements\\_Methodology\\_PUBLISHED.pdf](https://www.aemo.com.au/-/media/Files/Electricity/NEM/Security_and_Reliability/System-Security-Market-Frameworks-Review/2018/Inertia_Requirements_Methodology_PUBLISHED.pdf).

however it is able to act toward correcting a supply imbalance and restoring system frequency<sup>12</sup>. Both these power system capabilities are relevant to advanced inverters and their role in supporting the power system as it transitions to operating with fewer synchronous generators online.

## 2.3 Defining advanced inverters

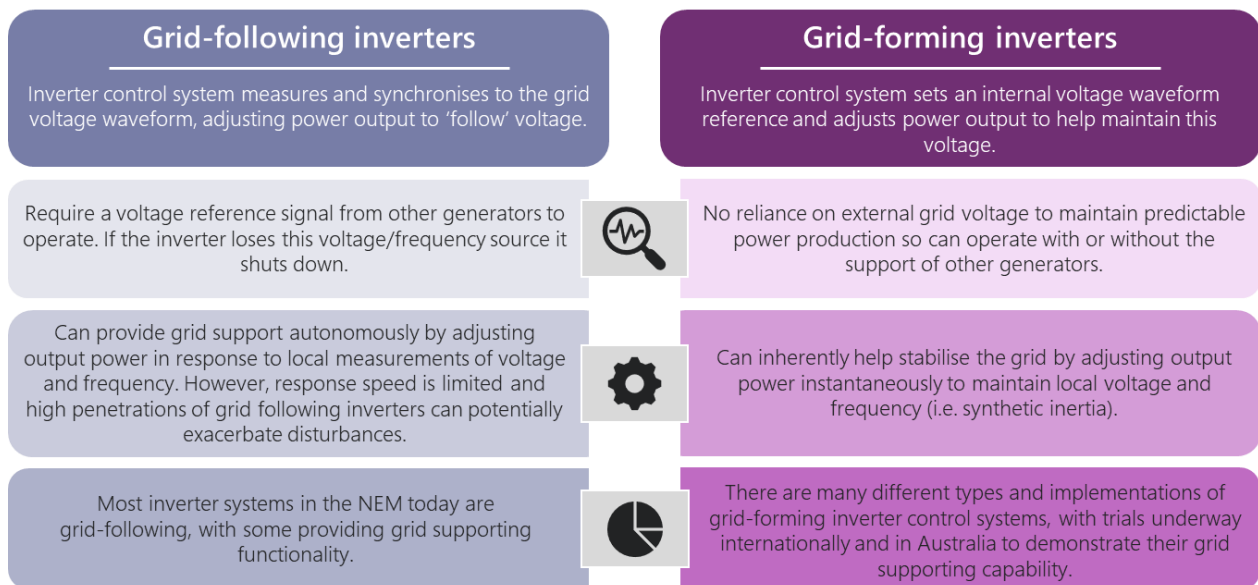
The terminology surrounding advanced grid-scale inverters is not yet clearly defined. Broadly, grid-following inverters synchronise to the grid voltage waveform, while grid-forming inverters set their own internal voltage waveform reference. This report takes a capability- and application-led approach to describe functionality within these two categories.

Due to the complexity of inverters and the rapid pace of their development, it is challenging to identify simple definitions to describe their operation. The term ‘advanced grid-scale inverters’ is used in this paper to cover inverters with the capability to directly support power system operations by delivering the capabilities listed in Table 1. This contrasts with today’s NEM IBR fleet, where grid-following inverters – without the majority of these capabilities – are dominant.

The term ‘grid-forming inverter’ is widely used to describe any advanced grid-scale inverter, however the precise set of capabilities and functionality of these devices can vary significantly by design and application. As such there is not a firm international consensus as to the specific definition of ‘grid-forming inverters’.

This paper uses the terms defined in Figure 4 to broadly distinguish between categories of inverters. These descriptions are not intended to be a complete definition of these categories, but rather to broadly group the consistent descriptions gathered through stakeholder interviews and the existing literature. AEMO has elected to take a service- and application-led approach to defining the ways advanced inverters could support power system operation to provide specific guidance within these broad categories.

**Figure 4 Broad categories of inverters**



## 2.4 The grid-forming inverter system

Grid-forming inverters deliver many of the grid stability functions discussed in Section 2.2 using rapid changes in their power level. This requires a readily available and flexible energy source on the direct current

<sup>12</sup> See [https://aemo.com.au/-/media/files/electricity/nem/security\\_and\\_reliability/reports/2017/ffr-working-paper.pdf](https://aemo.com.au/-/media/files/electricity/nem/security_and_reliability/reports/2017/ffr-working-paper.pdf).

(DC) side of the inverter that can be quickly accessed to satisfy any need to increase (or decrease) power output on the alternating current (AC) side.

This energy can come from several sources, including:

- Chemical energy stored in batteries.
- Kinetic energy stored in the spinning blades of a wind turbine.
- Electrical energy supplied across a high voltage DC (HVDC) link.

It may be possible to deliver some capabilities by retaining headroom in the operation of a VRE generator such as solar photovoltaic (PV), however this carries an opportunity cost and might impact the financial viability of the plant. Most pilot grid-forming inverter projects use batteries as a stored source of energy.

The quantity of energy availability required for a grid-forming inverter system will depend on the applications served (see Section 3). Additionally, the energy requirements may be influenced by the level of dependability and predictability needed by each application. For example, a grid-forming wind farm can use the energy stored in the spinning turbine blades to increase its energy output to provide an inertial response, but this action will slow the turbine down. While the turbine accelerates back up to normal operating speed it is unable to respond to further events, leaving a period of time where it cannot deliver the desired service (see Appendix A1.4). Determining the level of required energy storage for a grid-forming inverter system is complex and will have cost impacts on the plant design. These impacts are discussed further in Section 4.3.

## 2.5 Performance comparison of advanced inverters

Based on the definitions in Figure 4, an assessment of the performance potential of each category of inverters can be made against the power system requirements specified in Table 1. Table 2 shows a performance comparison of each category of inverters alongside synchronous machines by adapting findings from a research report<sup>13</sup> by the European Network of Transmission System Operators for electricity (ENTSO-E), which represents 43 electricity transmission system operators (TSOs) from 36 countries across Europe.

**Table 2 Performance comparison of grid-connected generation**

Service/capability	Grid-following inverter system	Grid-forming inverter system	Synchronous machines
Can contribute to system strength		✓	✓ <sup>A</sup>
Can have positive disturbance withstand (active power oscillation damping)		✓	✓
Can have positive disturbance withstand (fault ride-through capability)	✓	✓	✓
Can contribute to system inertia		✓ <sup>B</sup>	✓
Can contribute to FFR	✓	✓	
Can contribute to primary frequency response	✓	✓	✓
Can support a power system island with supply balancing and secondary frequency response	✓	✓	✓
Can initiate or support system restoration	✓ <sup>C</sup>	✓	✓

A. Synchronous machines can usually contribute to system strength much more than IBR due to their higher overload capacity.

B. A grid-forming inverter system requires energy storage to deliver inertia. See Section 2.4.

C. Grid-following inverters can support but not initiate system restoration.

<sup>13</sup> See [https://eepublicdownloads.entsoe.eu/clean-documents/Publications/SOC/High Penetration of Power Electronic Interfaced Power Sources and the Potential Contribution of Grid Forming Converters.pdf](https://eepublicdownloads.entsoe.eu/clean-documents/Publications/SOC/High%20Penetration%20of%20Power%20Electronic%20Interfaced%20Power%20Sources%20and%20the%20Potential%20Contribution%20of%20Grid%20Forming%20Converters.pdf).

An advantage all inverter-based control systems have over synchronous machines is that their performance capability can be tuned to the specific network conditions where they are connected, as many aspects of their performance are determined by software. Synchronous machines are not able to easily re-tune many of their performance capabilities, and some (such as inertia) are fixed completely, as they are determined by the physical aspects of the machine itself.

A synchronous machine may have an advantage over an inverter-based system through its large overcurrent (or fault current) capability. Overload capacity of present inverter-based systems is generally limited thermally by their electrical components to about 1-2 times their rated capacity, whereas synchronous machines can provide up to 5-6 times overload capacity.

### 3. Applications of advanced inverters

AEMO has identified and prioritised four power system applications for advanced grid-scale inverters in this white paper.

These applications provide increasing capability to support the transition of the power system, encompassing the range of capabilities described in Section 2.2.

As the NEM transitions to a higher penetration of IBR, the essential system capabilities currently provided by synchronous generators must be either substituted or maintained by IBR or other equipment such as synchronous condensers.

The research for this white paper identified four applications relevant to advanced grid-scale inverters from the perspective of operating a gigawatt-scale interconnected power system with few or no synchronous units online. These applications are summarised in Table 3.

**Table 3 Applications identified as relevant to advanced grid-scale inverters**

Application	Description
<b>Connecting IBR in weak grid areas</b>	Capability to maintain stable operation in weak grid areas to meet IBR performance obligations, and potentially to provide system strength to support the connection of other nearby IBR plant. This application provides localised capability to stabilise nearby IBR generation, but does not necessarily support the broader power system.
<b>Supporting system security</b>	Capabilities to maintain system security that are predominantly provided by synchronous generators today, such as inertia and system strength, to support the broader power system as it transitions to operating with fewer synchronous generators online.
<b>Island operation</b>	Capabilities to maintain stability and supply balancing at a high enough level to support areas of the grid that become separated from the main synchronous system when operating under high penetrations of IBR.
<b>System restart</b>	Capability to energise the local network during the challenging conditions of a black system, or to assist with the restoration process.

Each of the four applications require specific combinations of the power system capabilities described in Section 2.2, at varying levels.

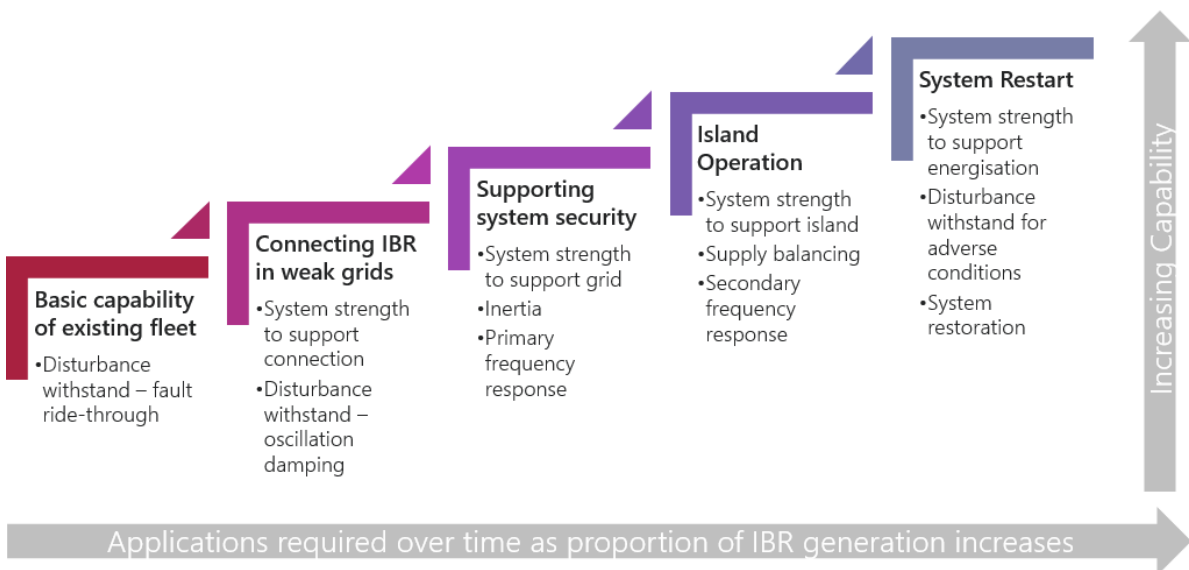


For example, the system restart process requires generators to provide current above that necessary in normal grid operation on an already energised network.

Figure 5 shows the combinations of technology capabilities required for each of the four advanced inverter applications alongside that of the existing grid-following IBR fleet.

As the NEM transitions toward operation with fewer synchronous machines, increasing capability will be needed from IBR generation in line with these applications. Initially, grid-forming inverters will be used to support the connection of IBR in weak grid areas, while this technology is tested and developed to support the broader operation of the synchronous power system. Over time, if sufficient focus and development occurs, and as confidence is built around these capabilities, grid-forming IBR is expected to provide the potential to manage islanded regions and ultimately to support system restart.

**Figure 5 Capabilities required for advanced grid-scale inverter applications**



### 3.1 Connecting IBR in ‘weak’ grid areas

#### Power system requirements

- System strength to support IBR generation connection.
- Disturbance withstand (fault ride-through and oscillation damping).

#### Key findings

- Advanced inverters could help IBR generators meet their performance obligations in areas of low system strength, and might provide system strength to support nearby IBR generators, potentially as an alternative to synchronous condensers.

#### Technology maturity

- Stable operation of grid-forming battery energy storage systems (BESS) in weak grid areas demonstrated at small scale. Simulation indicates potential for grid-forming BESS to stabilise selected areas of the NEM but no demonstrated examples to date. Tuning of grid-following IBR to mitigate voltage oscillations has been demonstrated in the NEM (see Appendix A1.1).

#### Relevant case studies in Appendix A1

- Case studies 1, 2 and 3.

The NEM is at the international forefront of managing issues associated with low system strength. Wind and solar IBR tend to be located where there is abundant wind and sunlight. In the NEM, these areas are typically located far from load centres and are also remote from synchronous machines. As a result, these IBR are often located in areas of low system strength ('weak' grid areas)<sup>14</sup>.

AEMO has previously declared system strength shortfalls in South Australia, Tasmania, Victoria, and Queensland, and is currently working with local TNSPs to address those<sup>15</sup>. Additionally, new connecting generators must currently ensure that they do not degrade local system strength because of their connection and must provide remediation if they do so<sup>16</sup>. In weak grid areas, this can potentially necessitate the installation of costly equipment such as synchronous condensers.

The Australian Energy Market Commission (AEMC) is currently working through a National Electricity Rules (NER) change request to promote efficient management of system strength on the power system<sup>17</sup>, which would influence the framework that governs the system strength requirements for new generation connections if implemented.

Grid-forming inverters have shown (albeit in limited examples) that they can remain stable in weak grid areas, with the capability to operate at low short circuit ratios significantly beyond where existing grid-following inverter-based generation can perform (see Appendix A1.1). This capability may assist new grid-forming connections to meet their performance standards in these areas.

Grid-forming inverter systems can provide fault current (a proxy for system strength) and can theoretically provide a system voltage waveform reference to stabilise the output of nearby grid-following inverter-connected generation and damp out voltage oscillations propagating through the network. This is particularly useful in parts of the network with low system strength, where a grid-forming inverter system might allow other grid-following IBR in the area to meet their necessary connection requirements.

The installation of grid-forming inverters with a voltage waveform output that is calibrated to the network conditions is theoretically a substitute to the installation of synchronous condensers for the purpose of supporting VRE connections in low system strength areas. Grid-forming battery systems can be highly flexible and are able to be re-tuned more effectively than synchronous condensers when there are changes to the network in the area they are operating.

Grid-forming inverters also have the advantage of being able to utilise the existing renewable connection's infrastructure without connecting the additional switchgear for a synchronous condenser, and can provide capabilities beyond system strength and inertia.

Desktop studies have shown the potential of grid-forming BESS to stabilise nearby IBR generation in a weak area of a bulk power system without the need for additional synchronous condensers (see Appendix A1.1 and Appendix A1.2), however AEMO has not identified any examples of this capability being demonstrated in practice.

The potential for new IBR connections to use grid-forming inverters to meet their performance standards – and perhaps enable other nearby IBR connections to operate in weak grid areas with their assistance – is expected to be demonstrated in practice over coming years as confidence grows in this technology.

---

<sup>14</sup> See [https://www.aemo.com.au/-/media/files/electricity/nem/planning\\_and\\_forecasting/Operability/2020/2020-System-Strength-and-Inertia-Report](https://www.aemo.com.au/-/media/files/electricity/nem/planning_and_forecasting/Operability/2020/2020-System-Strength-and-Inertia-Report).

<sup>15</sup> All current system strength shortfalls are listed at <https://aemo.com.au/energy-systems/electricity/national-electricity-market-nem/nem-forecasting-and-planning/planning-for-operability>.

<sup>16</sup> Detailed information on the system strength assessment for new connecting generators is available in AEMO's system strength impact assessment guidelines. See [https://www.aemo.com.au/-/media/files/electricity/nem/security\\_and\\_reliability/system-security-market-frameworks-review/2018/system\\_strength\\_impact\\_assessment\\_guidelines\\_published.pdf?la=en&hash=771B8F6BC8B3D1787713C741F3A76F8B](https://www.aemo.com.au/-/media/files/electricity/nem/security_and_reliability/system-security-market-frameworks-review/2018/system_strength_impact_assessment_guidelines_published.pdf?la=en&hash=771B8F6BC8B3D1787713C741F3A76F8B).

<sup>17</sup> See <https://www.aemc.gov.au/rule-changes/efficient-management-system-strength-power-system>.

## 3.2 Supporting system security

### Power system requirements

- Inertia.
- Primary frequency response.
- System strength to support wider grid.
- Disturbance withstand.

### Key findings

- Advanced inverters could provide capabilities to support the secure operation of a synchronous power system like the NEM. Demonstration of these at scale is critical if this technology is to replace the capabilities of synchronous machines.

### Technology maturity

- Grid-forming inverters have been shown in pilot trials and desktop studies to provide capabilities to support system security. It is yet to be shown in practice whether they will be able to replace the capabilities delivered by synchronous machines entirely.

### Relevant case studies in Appendix A1

- Case studies 3 and 4.

Today, the NEM always operates with combinations of synchronous generators online, in all regions. These synchronous generators provide the capabilities listed in Section 2.2 at high enough levels to ensure secure operation of the power system, factoring in the requirements of both load and IBR that may not have these capabilities. As the NEM moves toward periods of operation with fewer synchronous generators online, these capabilities will need to be delivered by alternative methods.

Grid-forming inverters have the potential to provide system strength at higher levels than required to simply facilitate their own connection (see Section 3.1), and can also provide capabilities to support the operation of the bulk power system, such as inertia, and primary and secondary frequency control (see Section 2.2). These capabilities are all required by gigawatt-scale power systems to maintain frequency and voltage stability under normal operation and during contingency events, noting that additional capability might be required to cater for more extreme operating conditions such as islanding or system restart (see sections 3.3 and 3.4).

Grid-forming inverters are used to operate AC microgrids (tens of MW scale) today without any synchronous generating units online, demonstrating the potential for this technology to support system security (see Appendix A1.3). To AEMO's knowledge, operating gigawatt-scale power systems without synchronous machines has not been demonstrated anywhere in the world. To achieve this, further work is needed to demonstrate the delivery of these capabilities at scale while interacting with other power system assets, including synchronous machines, grid-following IBR, DER, and network protection systems. These interactions may in turn influence the design of grid-forming inverter systems. For example, if a certain level of fault current needs to be provided to maintain the performance of network protection systems then that could mean inverters need to be built to a suitable overcurrent rating.

It is likely that grid-forming inverters could be used to stabilise other nearby grid-following IBR (see Section 3.2), raising the question of what proportion of generating units will need to have grid-forming capability. Some OEMs have indicated their equipment can be configured to operate in grid-forming or grid-following mode, meaning there may be some future flexibility to this proportion, as well as the potential for dynamic configuration of operating modes during testing or commissioning. Some developers may choose to install equipment capable of grid-forming but initially operate them in grid-following mode as a

means of future-proofing their design. However, tuning of inverter settings after the plant has been commissioned may trigger re-assessment of performance requirements, potentially acting as a barrier to flexibility (discussed further in Section 4.3).

Internationally, the push to replace the capabilities of synchronous machines with grid-forming inverter technology is occurring under varying approaches, depending on local conditions and urgency. In the United Kingdom, emerging grid stability issues relating to the decline in transmission-connected synchronous generation have led to National Grid establishing a ‘stability pathfinder’<sup>18</sup> program, to identify cost-effective solutions to challenges such as declining inertia. To enable grid-forming inverters to play a role in this program, National Grid has begun the process of drafting grid specifications for these devices<sup>19</sup>. In contrast to this targeted approach, the United States Department of Energy’s Research Roadmap on Grid-Forming Inverters<sup>20</sup> describes a broad strategic perspective where they “envision a future where grid-forming inverters are integrated into electric grids of steadily increasing size and complexity over the next 10–30 years”<sup>21</sup>, once a research base and robust standards environment have been established.

In Australia, the need to develop grid-forming inverter support for system security is rapidly building, as shown in Section 2.1. International learnings and development will be valuable in informing domestic decision-making, however the pace of change in the NEM necessitates early action that may come in advance of other jurisdictions. To support this need for early action, trials funded by the Australian Renewable Energy Agency (ARENA)<sup>22</sup> are now underway to demonstrate grid-forming inverter capabilities such as synchronous inertia. Collaboration between grid operators, NSPs, OEMs, developers, researchers, and policy-makers will be needed to ensure a harmonised approach as the capability of this technology is proven up.

### 3.3 Island operation

#### Power system requirements

- Support power system island with supply balancing and secondary frequency response.
- Inertia and primary frequency response sufficient to support island.
- System strength to support island.
- Disturbance withstand sufficient to survive islanding event.

#### Key findings

- Grid-forming inverters have demonstrated the capability to sustain island operation of microgrids without any synchronous machines. Maintaining a secure regional-scale island after a system split event is more challenging and further work is required to demonstrate advanced inverter technology under these conditions.

#### Technology maturity

- There have been many successful real-world examples of grid-forming inverters supporting a sub-transmission system island in a separation event, however support of larger regional-scale islands without synchronous generators has not yet been demonstrated.

#### Relevant case studies in Appendix A1

- Case study 3.

<sup>18</sup> See <https://www.nationalgrideso.com/future-of-energy/projects/pathfinders/stability>.

<sup>19</sup> See <https://www.nationalgrideso.com/document/159296/download>.

<sup>20</sup> Research Roadmap on Grid-Forming Inverters, at <https://www.nrel.gov/docs/fy21osti/73476.pdf>.

<sup>21</sup> Powering On with Grid-Forming Inverters, at <https://www.energy.gov/eere/solar/articles/powering-grid-forming-inverters>.

<sup>22</sup> See <https://arena.gov.au/projects/hornsedale-power-reserve-upgrade/> and <https://arena.gov.au/projects/transgrid-wallgrove-battery/>.

A system split event is an abnormal grid event leading to separation of the system into parallel asynchronous zones. Such events are infrequent in the NEM.

System split events that leave just one or a small cluster of nearby generating units separated from the power system are distinct from those that separate the system into larger regions of dispersed units. The former might be described as a microgrid, and has the challenge of providing all required energy and system services from a single location but does not have to manage interaction with other generating units located at a distance. The operation of microgrids is important from a long-term power system resilience perspective, however AEMO's current focus is to determine how advanced inverters can support the operation of complex regional-scale islands.

In large power system islands, a proportion of the remaining synchronous machines are required to maintain the voltage waveform, phase angle and frequency of the system. To date, this has only been possible with a minimum number of synchronous machines (generation or possibly synchronous condensers).

Typically, system split events will occur in an edge of grid location (such as South Australia, Queensland, or Tasmania in the NEM) or across 'weak' transmission corridors. Exports or imports before the system split event become power imbalances for the separate islands after the split, which can lead to significant Rate of Change of Frequency (RoCoF) events. To ensure power systems can avoid collapse under these large-scale system splits, distributed fast acting dynamic support for a range of stability challenges (maintaining healthy frequency, voltage, and phase angle) is needed.

Past events (such as the South Australia split in 2016 and European Union split in 2006) have demonstrated that the capabilities provided by online synchronous units have been critical to maintaining system stability and avoiding system collapse in the islanded region<sup>23</sup>. As the NEM moves toward operation with fewer synchronous units online, alternative means are required to undertake these tasks.

Studies by ENSTO-E<sup>24</sup> indicate that grid-forming inverters could help avoid system collapse during an islanding event, provided they are available in adequate volume and with adequate geographical diversity. The current fleet of grid-following IBR in the NEM may not be able to provide the capabilities required to survive and maintain an island in the absence of synchronous generation. Internationally, research is underway to investigate combinations of grid-forming and grid-following IBR, and synchronous condensers, that could potentially support an island in the absence of synchronous generation<sup>25</sup>.

Maintaining a stable regional-scale island requires multiple generating units to work together to survive the sudden shift in operating conditions that occur during a system split event, and continue to collectively provide the capabilities required to maintain stability on the islanded region. Frequency control is of particular importance, with sufficient inertia and not just Primary Frequency Response (PFR) capability alone required across the islanded fleet.

The ability for grid-forming IBR to form a secure regional-scale island in the absence of synchronous machines has not yet been demonstrated. At a distribution scale, the Energy Storage for Commercial Renewable Integration (ESCRI) project in South Australia has demonstrated the capability to operate as an island, supported by a 30 MW grid-forming battery. Further details on this project are in Appendix A1.1.

System stabilising capabilities provided by advanced IBR may provide a new means of managing islanded operation in the NEM. Advanced inverter-based BESS will play an important role in island operation as they can help maintain the supply-demand balance in an islanded system alongside VRE generators.

---

<sup>23</sup> See [https://www.aemo.com.au/-/media/Files/Electricity/NEM/Market\\_Notices\\_and\\_Events/Power\\_System\\_Incident\\_Reports/2017/Integrated-Final-Report-SA-Black-System-28-September-2016.pdf](https://www.aemo.com.au/-/media/Files/Electricity/NEM/Market_Notices_and_Events/Power_System_Incident_Reports/2017/Integrated-Final-Report-SA-Black-System-28-September-2016.pdf).

<sup>24</sup> See [https://eepublicdownloads.entsoe.eu/clean-documents/Publications/SOC/High\\_Penetration\\_of\\_Power\\_Electronic\\_Interfaced\\_Power\\_Sources\\_and\\_the\\_Potential\\_Contribution\\_of\\_Grid\\_Forming\\_Converters.pdf](https://eepublicdownloads.entsoe.eu/clean-documents/Publications/SOC/High_Penetration_of_Power_Electronic_Interfaced_Power_Sources_and_the_Potential_Contribution_of_Grid_Forming_Converters.pdf).

<sup>25</sup> 'Enabling the energy transition by providing solutions for the technological challenges', MIGRATE 2019, at [https://www.h2020-migrate.eu/Resources/Persistent/b955edde3162c8c5bf6696a9a936ad06e3b485db/19109\\_MIGRATE-Broschuere\\_DIN-A4\\_Doppelseiten\\_V8\\_online.pdf](https://www.h2020-migrate.eu/Resources/Persistent/b955edde3162c8c5bf6696a9a936ad06e3b485db/19109_MIGRATE-Broschuere_DIN-A4_Doppelseiten_V8_online.pdf).

## 3.4 System restart

### Power system requirements

- Initiate or support system restoration.
- Supply balancing.
- Inertia, primary and secondary frequency response sufficient to support restoration process.
- System strength to support energisation.
- Disturbance withstand for adverse conditions during system restoration.

### Key findings

- Energising a section of the power system can require generators to operate under challenging conditions, including the need to provide current above that necessary in normal grid operation on an already energised network. Grid-forming inverters have the potential to support or even initiate system restart, however this has yet to be demonstrated at scale.

### Technology maturity

- Proven ability to provide system restoration capability at distribution to sub-transmission levels. Energisation at a bulk power system level has not yet been demonstrated.

### Relevant case studies in Appendix A1

- Case studies 3, 4 and 5.

Black system events occur rarely in the NEM (South Australia in 2016, northern Queensland in 2009, and New South Wales in 1964). While these events are rare, system operators must have resources available to restart and restore the system to a secure and reliable operating state, as safely and quickly as possible, in the event of a major supply disruption.

In the NEM, system restoration capability is supported by System Restart Ancillary Service (SRAS)<sup>26</sup>.

To date, SRAS has been serviced in a top-down manner, where large synchronous generating systems start the transmission system first and then sequentially energise other energy sources and load. Energising a network generally requires a long duration, dispatchable power source with sufficient short circuit power. Only a small portion of synchronous generators in the NEM can provide SRAS, because they must be designed specifically to do so.

Energising a section of the power system can require system restart units to operate in adverse conditions<sup>27</sup>, including the need to provide current above that necessary in normal grid operation on an already energised network. For any generating unit to provide this capability, it needs to prove that it can:

- Start by itself and not need an external supply to operate auxiliary load.
- Control voltage and frequency.
- Supply the necessary short duration energisation and fault currents.
- Deliver power for hours at a time while other sources of supply come online.
- Preferably, provide additional inertia to make frequency control easier on a restored network.

<sup>26</sup> See <https://aemo.com.au/en/energy-systems/electricity/national-electricity-market-nem/system-operations/ancillary-services/system-restart-ancillary-services-guideline>.

<sup>27</sup> See [https://www.hvdccentre.com/wp-content/uploads/2020/02/EPRI-HVDC-Restoration-Project-Final-Webinar\\_20200213.pdf](https://www.hvdccentre.com/wp-content/uploads/2020/02/EPRI-HVDC-Restoration-Project-Final-Webinar_20200213.pdf).

A difficulty in restarting a network can be energising large power transformers, which requires these units to deliver large amounts of current for a short duration, meaning they must be designed for a high overload rating. For grid-forming inverters to provide significant system restart capability, they would need to be rated appropriately and be fed from a suitably sized energy source, such as a very large battery or HVDC link.

Appendix A1.5 details a desktop study investigating how a grid-forming inverter could initiate restarting a portion of the Scottish grid using a 'soft-start' method to limit surge current requirements. Examples such as this demonstrate the potential for grid-forming inverters to provide system restart services in innovative ways, however it is important to consider the restoration process from end-to-end as it may not always be possible to avoid the need for high overload current requirements.

Due to their typical location on the network, grid-forming inverters might be used for either a top-down or bottom-up (distribution system-initiated) system restart approach:

- Often utility-scale IBR are in remote areas away from load centres. Grid-forming inverters on these plants could assist in a top-down system restart approach in a similar manner to the current process.
- For IBR that is connected via the distribution network, a bottom-up approach could be used. This would involve energising distribution load first, before energising up the transmission network to larger generators.

Over time, the number of large synchronous generating units with SRAS capability is likely to reduce as these generators are retired. The current fleet of IBR cannot provide SRAS capability, so new resources will be required to ensure restoration standards can continue to be met into the future.

In November 2020, AEMO updated its SRAS Guideline to contain a description of new *restoration support services* that may be procured to assist with restoration, along with a system restart service<sup>28</sup>. Restoration support services can include services provided by IBR to assist with dynamic reactive power support, and utilise their fast ramp rates for frequency control, via load balancing, in the system restart process. The system restart process requirements will need to evolve over time to reflect the capability of advanced inverters and their potential to replace traditional means of delivering SRAS.

## 4. Barriers and enablers

This section explores four key barriers to, and enablers for, the adoption of advanced grid-scale inverters in the NEM.

Stakeholders interviewed by AEMO during the development of this paper indicated that inverter manufacturers are confident in the capability of their grid-forming devices and associated control systems to support the power system. However, barriers do exist between the development of this technology and its deployment at scale in the NEM to meet the applications identified in Section 3.

Action is required by market bodies, government, and industry to overcome these barriers and enable rapid deployment of advanced inverters to meet the growing demands of the transitioning power system.

Table 4 summarises four key barriers and possible enablers for the adoption of advanced grid-scale inverters.

---

<sup>28</sup> See <https://aemo.com.au/consultations/current-and-closed-consultations/sras-guideline-2020>.

**Table 4 Key barriers and possible enablers for uptake of advanced grid-scale inverters**

Barrier or enabler	Description
<b>Capability specification</b>	<ul style="list-style-type: none"> <li>• Grid connection specifications are needed to provide clear requirements to OEMs and developers.</li> <li>• Initial targeted approach could inform future design of standards and grid codes.</li> </ul>
<b>Capability demonstration</b>	<ul style="list-style-type: none"> <li>• Maturity of advanced inverter capability varies across the range of required power system capabilities.</li> <li>• Limited deployment and untested performance in large power systems.</li> </ul>
<b>Costs</b>	<ul style="list-style-type: none"> <li>• Grid-forming infrastructure currently carries a cost premium.</li> <li>• Demonstrating compliance is complex, requiring time and engineering expertise.</li> <li>• Timeline and performance uncertainty can influence financing costs.</li> </ul>
<b>Revenue</b>	<ul style="list-style-type: none"> <li>• Many potentially valuable capabilities to support the power system do not have established revenue streams.</li> <li>• Targeted revenue streams could drive initial uptake.</li> </ul>

## 4.1 Capability specification

According to Matevosyan, Badrzadeh in their Energy Systems Integration Group (ESIG) report<sup>29</sup>, grid operators, manufactures, researchers, and policy-makers need to continually discuss conditions under which grid-forming technology is needed, and the performance requirements should be clearly defined in grid codes or standards. OEMs then can develop equipment with new capabilities that balance performance and costs. This dialogue is crucial to ensure specifications efficiently meet the needs of the power system and accommodate perspectives from across industry.

Well-defined grid connection specifications for advanced inverters could accelerate their uptake by providing clear requirements to OEMs and streamlining the connection approval process for developers. Building these specifications in line with the applications raised in Section 3 would ensure new connections are designed in line with power system requirements. Clearly defining the desired capabilities from advanced inverters from a power system operations perspective would provide an initial step toward iterative development of more detailed specifications. Reworking some of the existing NER performance requirements, which at the time were written to cater for synchronous generation and grid-following IBR, would provide a clearer pathway for assessing grid-forming inverters during new connection applications.

Specifications do not necessarily have to be mandatory requirements on grid connections. For example, in the United Kingdom, National Grid has begun drafting a grid code for grid-forming inverters alongside its ‘stability pathfinder’ program (see Section 3.2). This demonstrates a targeted approach, leveraging a funded program of work to start developing specifications addressing the need for new inertia services. Over time, such specifications could inform the development of more formal technical standards to drive an internationally harmonised approach to grid-forming capability specification. Jurisdictions could then determine whether there would be net benefit from making these standards mandatory to cater for local conditions.

It may not be necessary for all, or even most, inverters to carry grid-forming capability to support a grid operating with high IBR penetration. Future grid codes will need to consider how diverse combinations of grid-forming and grid-following inverters, synchronous condensers, and synchronous generators will interact to support a secure and resilient power system. Technical specification may play a role in guiding this generation mix, as may market and non-market revenue mechanisms (discussed further in Section 4.4).

Interviews conducted during the development of this paper indicated stakeholder perception (internationally and within Australia) of a standstill between the three major interested parties: grid operators, OEMs, and developers. Grid operators are cautiously asking for clear definitions of what this technology is capable of and

<sup>29</sup> At [https://www.esig.energy/wp-content/uploads/2020/01/MPE2933072\\_7Matevosayn\\_preprint.pdf](https://www.esig.energy/wp-content/uploads/2020/01/MPE2933072_7Matevosayn_preprint.pdf).



what it cannot (currently) do. The OEMs are asking for clear, functional grid specifications detailing how grid-forming inverter connections will be assessed to provide sufficient incentive for them to develop commercial grid-forming inverter systems for bulk power system applications. Developers are asking how they can utilise this emerging technology in clearly defined markets to unlock plant capability.

Clearly defined requirements for power system support are required to break this standstill, or advanced inverter uptake will likely remain slow and untargeted. Without these, developers are unlikely to consider implementing functionality above the requirements for connecting IBR in weak grid areas (see Section 3.1), as there will be no guidance as to the necessary capability. This barrier toward the uptake of advanced inverters should be addressed as soon as possible, and Australia is at the forefront of this challenge due to the pace at which IBR generation is displacing synchronous generation (see Section 2.1).

## 4.2 Capability demonstration

Despite the potential of advanced grid-scale inverters to support a system with high penetration of IBR, stakeholders have noted that this technology is not necessarily a “silver bullet” for solving all challenges of the energy transition. Advanced inverters have shown their capability to provide a range of valuable capabilities in a bulk power system (see Section 3), however the maturity and demonstrated scale of these capabilities varies.

In a survey of grid-forming inverter applications carried out by ESIG<sup>30</sup>, Australia is highlighted as one of the world leaders for analysis and large-scale trials of this technology; the Dalrymple Battery and the Hornsdale Power Reserve<sup>31</sup> are given as relevant examples.

Table 5 summarises the maturity of advanced inverters for the four identified applications from Section 3.

**Table 5 Maturity of advanced inverter applications in large-scale power system**

Application	Technology maturity	Real-world examples (see Appendix A1)
<b>Connecting IBR in weak grid areas</b>	Stable operation of grid-forming BESS in weak grid areas demonstrated at small scale. Simulation indicates potential for grid-forming BESS to stabilise selected areas of the NEM but no demonstrated examples to date. Tuning of grid-following IBR to mitigate voltage oscillations has been demonstrated in the NEM, see Appendix A1.1.	Limited examples
<b>Supporting system security</b>	Isolated examples on large power grids. Standards and market mechanisms being drafted in the UK.	Limited examples
<b>Island operation</b>	Successful applications at sub-transmission level, including in the NEM. Needs proving up for regional-scale islands.	Small-scale
<b>System restart</b>	Demonstrated at distribution level and simulated examples of initiating transmission restoration.	Small-scale

Stakeholders noted a major barrier to the uptake of advanced inverters at scale is their limited deployment and untested performance in large power systems. Views as to the readiness of advanced inverter capabilities vary widely, indicating that more needs to be done to demonstrate the capability of this technology to meet the applications described in Section 3, and to build confidence in the potential of advanced inverters to meet the needs of a power system with fewer synchronous generating units online. This includes testing and development of early-stage functionality at small scale, and demonstrating the performance of mature functionality at a large enough scale to provide meaningful results on a gigawatt-scale power system.

<sup>30</sup> See <https://www.esig.energy/event/g-pst-esig-webinar-series-survey-of-grid-forming-inverter-applications/>.

<sup>31</sup> See <https://arena.gov.au/projects/hornsdale-power-reserve-upgrade/>.

Testing of early-stage functionality requires a funding model that recognises the engineering and regulatory challenges that inevitably arise at this stage of the development curve. These challenges can lead to delays and expenditure that need to be accounted for in the project plan, and likely necessitate the involvement of a funding partner such as ARENA to support a viable project structure.

Demonstration of mature functionality at scale requires a support structure that enables safe and timely connection of projects under a framework that maximises learnings and outcomes.

Grid-scale batteries are connecting to the NEM at an unprecedented rate, and AEMO, OEMs, and developers need to work together to enable these installations to test advanced inverter capabilities on these projects under an appropriate framework. Unless this framework is established soon, developers of new grid-scale batteries may avoid deployment of advanced capabilities due to concern over complex connection requirements and potential delays to the commissioning process. This outcome would represent a missed opportunity for AEMO and the broader electricity sector to learn and gain confidence in this technology.

### 4.3 Cost of this capability

This section addresses the costs of deploying advanced grid-scale inverter functionality from the perspective of the additional costs associated with using a grid-forming inverter as opposed to a grid-following inverter. These include upfront infrastructure, compliance, and operational costs, and may reflect the cost risk of adopting a design that is not yet well understood by industry.

The additional cost of deploying grid-forming inverter technology might currently present a barrier to its uptake for some developers, who may elect to meet system strength and other grid requirements for their connection through traditional means rather than incurring any additional costs or risks associated with this technology. Overcoming this barrier could enable rapid deployment of grid-forming capability on projects that might otherwise select grid-following technology.

Consideration of costs associated with incorporating grid-forming technology to VRE projects is also important, particularly where this would require adding energy storage to a project (see Section 2.4). For example, to provide fault current during a network disturbance, a grid-forming inverter would need to be coupled with sufficient energy storage (such as a battery) to generate this higher current. Assessment of such projects requires complex trade-offs and is outside the scope of this paper.

Table 6 describes some of the cost influences of grid-forming inverter projects. The impact of these influences will vary depending on the application targeted by a given project, due to the service capabilities required for that application (see Section 3).

The immediate challenge is to minimise costs and risks associated with developing grid-forming projects early in the uptake curve. Later projects can then benefit from experience and efficiencies developed during earlier projects, as well as economy of scale as grid-forming technology becomes established internationally.

**Table 6 Cost influences on grid-forming inverter projects**

Cost influence	Description	Category
<b>Up-rated components</b>	Components with higher rating may be required to manage overload currents associated with system strength provision.	Infrastructure
<b>Cost premium for grid-forming inverter hardware</b>	OEMs may price new products to reflect development overhead and sales volumes. This premium is expected to reduce over time as sales increase and competition increases.	Infrastructure
<b>Operating at reduced capacity to provide headroom</b>	Opportunity cost reflecting that some system requirements (such as inertia) may require the plant to operate at a setpoint that reserves headroom for service delivery.	Operational
<b>Grid specification compliance</b>	More time may be required to achieve grid compliance when connecting new, complex technology, potentially leading to lost revenue and additional engineering expense. This cost influence will be particularly relevant for early adopters but is expected to reduce as industry experience is developed.	Compliance
<b>Re-tuning compliance costs</b>	Tuning of plant after initial commissioning can trigger re-assessment of plant performance under NER 5.3.9, potentially leading to changes to performance standards. This cost barrier can lead to reluctance to enable new functionality or optimise operation to suit changing conditions.	Compliance
<b>Capability demonstration in varying conditions</b>	Demonstrating capability to deliver complex power system support capabilities under varying conditions may require additional time and engineering expense.	Compliance
<b>Timeline and performance uncertainty</b>	The risk from adopting a novel technology may influence the cost of financing a project.	Finance

## 4.4 Revenue streams for this capability

In the absence of mandatory technical specifications to guide the deployment of advanced grid-scale inverters, encouraging their uptake in the NEM will require suitable incentives for developers to incorporate this technology into their projects. These could include sources of revenue such as:

- Delivery of market and non-market services.
- Provision of regulated services such as non-network augmentation.
- Direct funding from governments to support renewable energy programs.

As shown in Section 2.5, advanced inverters have the potential to provide most (and potentially all) system requirements required by a future power system with a high penetration of IBR generation. However, many of these capabilities are not yet fully valued, or are not easily accessible as revenue streams. Developing enduring frameworks to value and deliver these services will take time, and is a focus of the Energy Security Board’s (ESB’s) Post 2025 Market Design work<sup>32</sup>.

The delivery of a clear pathway for advanced inverters to unlock revenue will influence the speed of their adoption by industry in the medium term. Market bodies and industry need to work together to develop technical specifications and market and non-market mechanisms that can utilise grid-forming inverter capability effectively. In the United Kingdom, an initial step has been taken to provide grid-forming inverters access to revenue for provision of inertia and system strength services through National Grid’s ‘stability pathfinder’ program (see Section 3.2). This work offers a view of how revenue opportunities can drive the deployment of specific technology.

<sup>32</sup> See <https://esb-post2025-market-design.aemc.gov.au/>.

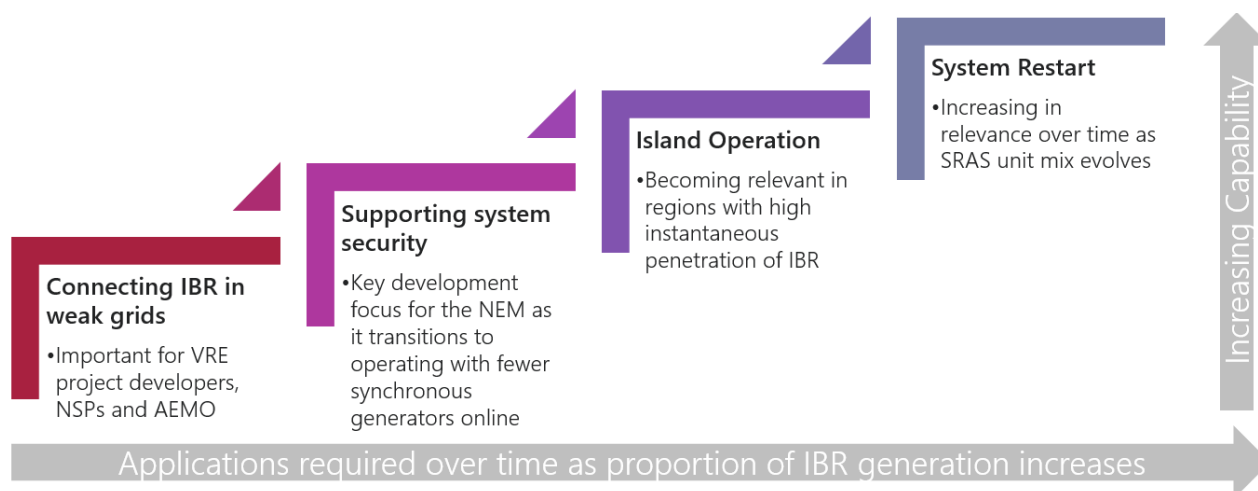
Section 4.3 discusses the costs faced by developers of grid-forming inverter systems, particularly those influencing near-term projects that are early in the adoption curve of this technology. To overcome this initial hurdle, direct funding may be needed to stimulate learning opportunities and to begin building fleet capacity.

## 5. Recommendations and next steps

Advanced inverters are an exciting new technology with tremendous potential being shown in theory and in trials across large power systems around the world, and particularly in Australia. However, while the potential is high, stakeholders have noted that this technology is not necessarily a ‘silver bullet’ for solving all challenges of the energy transition.

Figure 6 shows how the four potential applications for advanced inverters identified in Section 3 are expected to grow in relevance as technology maturity and system needs evolve.

**Figure 6** Increasing relevance of applications detailed in this paper



As noted in Section 2.4, advanced inverters need a firm energy source behind them to replace many of the capabilities historically provided by synchronous generators. Given the need to progressively reduce the NEM’s reliance on synchronous machines, AEMO recommends prioritising deployment of grid-forming capabilities on grid-scale BESS, as this technology provides capability to deliver firm energy behind the inverter. While large, standalone BESS provide a simple way to deliver grid-forming capability, smaller batteries (with storage capability of several minutes) coupled to VRE plants might also provide a flexible resource mix to cater for the applications described in this paper.

With a growing number of grid-scale batteries committed or proposed on the NEM, there is a rare window of opportunity to build grid-forming capabilities into this battery fleet today. This would enable testing and demonstration of these capabilities at scale, and begin to build a fleet that can support the power system as it transitions to high IBR penetration.

Given the speed of transition in the NEM, AEMO recommends a balanced approach that seeks to maximise low-regret opportunities to incorporate grid-forming capabilities on new grid-scale batteries, while prudently proving up the NEM’s ability to rely on grid-forming technology. To facilitate the fastest possible transition

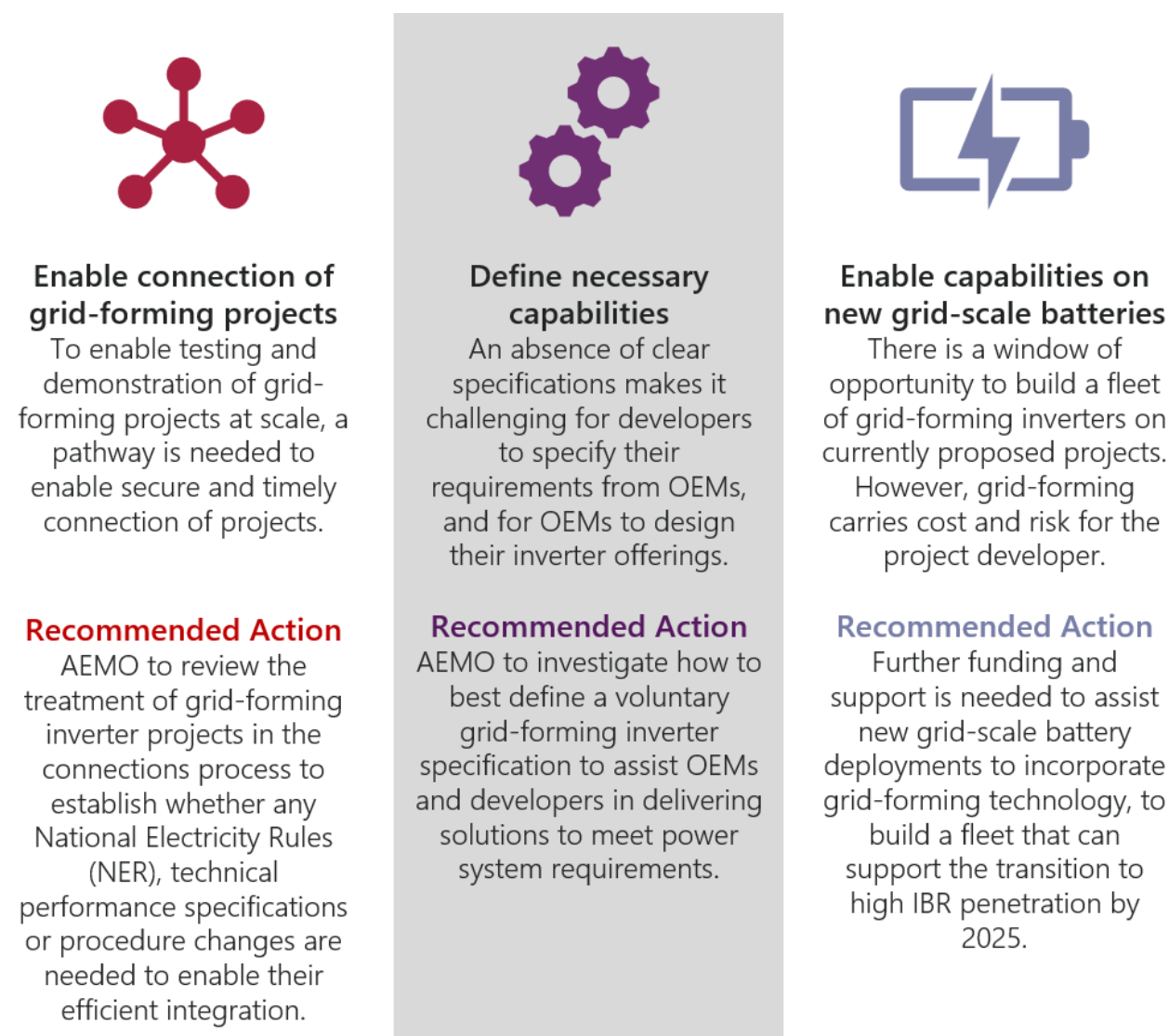
and seriously develop and capitalise on grid-forming inverter technology potential, more time and resources need to be spent across industry proving this technology at scale and overcoming barriers to its adoption.

Until the technology is sufficiently proven at scale, caution must be taken in how quickly the NEM can rely on these capabilities as primary providers of system stabilisation.

## 5.1 Recommendations

To begin capturing the opportunities presented by advanced grid-scale inverters, AEMO recommends immediate actions be taken across the three focus areas shown in Figure 7.

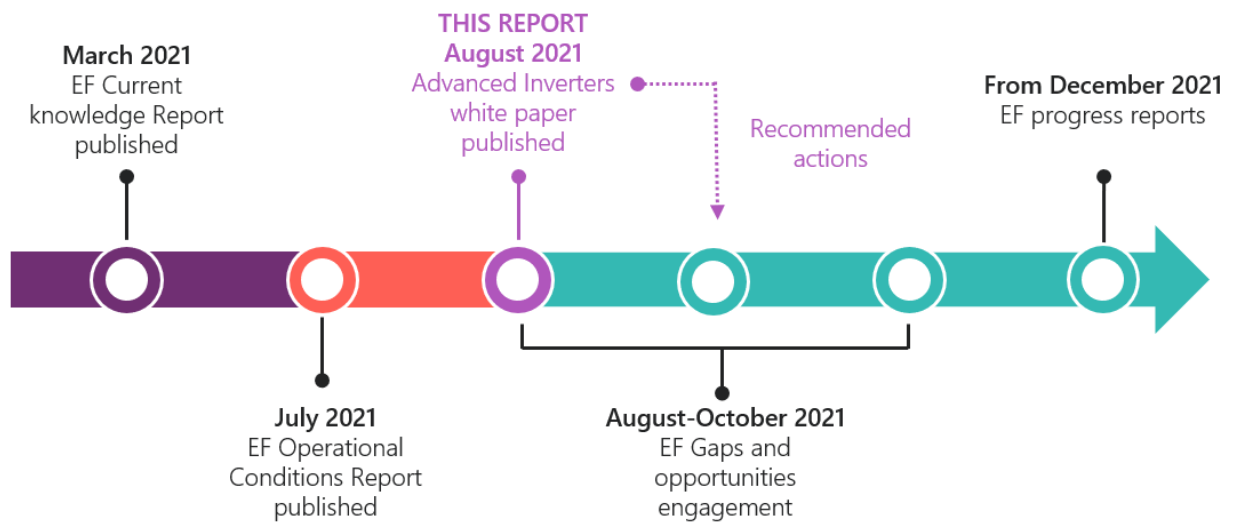
**Figure 7 Recommendations for immediate action**



## 5.2 Next steps

This report has been developed as part of AEMO's Engineering Framework as an accelerated effort to identify priority actions to help enable a promising emerging technology. The recommended actions outlined in Section 5.1 will be captured and tracked within the Engineering Framework process of prioritising gaps and opportunities needed to support system operation at times of high IBR and low synchronous generation. An overview of this timeframe is provided in Figure 8.

**Figure 8 Engineering Framework (EF) timeline**



To get in touch with AEMO regarding the contents of this white paper, to seek more information about how to engage in upcoming engagements for the Engineering Framework, or to sign up to AEMO's Engineering Framework mailing list, please contact AEMO at [FutureEnergy@aemo.com.au](mailto:FutureEnergy@aemo.com.au).

# Acronyms

Acronym	Term in full	Acronym	Term in full
<b>AC</b>	Alternating Current	<b>IBR</b>	Inverter-based resource/s
<b>AEMO</b>	Australian Energy Market Operator	<b>ISP</b>	Integrated System Plan
<b>ARENA</b>	Australian Renewable Energy Agency	<b>kV</b>	Kilovolt
<b>BESS</b>	Battery Energy Storage System	<b>MVA</b>	Megavolt-amperes
<b>DC</b>	Direct Current	<b>MW</b>	Megawatts
<b>EMT</b>	Electromagnetic transient	<b>MWh</b>	Megawatt hours
<b>EPRI</b>	Electric Power Research Institute	<b>NEM</b>	National Electricity Market
<b>ESB</b>	Energy Security Board	<b>NER</b>	National Electricity Rules
<b>ESCRI</b>	Energy Storage for Commercial Renewable Integration	<b>OEM</b>	Original Equipment Manufacturer
<b>ESIG</b>	Energy Systems Integration Group	<b>PFR</b>	Primary Frequency Response
<b>EV</b>	Electric Vehicle	<b>RIS</b>	Renewable Integration Study
<b>FCAS</b>	Frequency Control Ancillary Services	<b>RoCoF</b>	Rate of Change of Frequency
<b>FFR</b>	Fast Frequency Response	<b>SCR</b>	Short Circuit Ratio
<b>GW</b>	Gigawatt	<b>SRAS</b>	System Restart Ancillary Service
<b>HVDC</b>	High Voltage Direct Current	<b>SVC</b>	Static VAR Compensator
<b>Hz</b>	Hertz	<b>TNSP</b>	Transmission Network Service Provider
<b>Hz/s</b>	Hertz per second	<b>VRE</b>	Variable Renewable Energy

# A1. Case studies

The five case studies in this section were selected to highlight recent investigations and demonstrations of the advanced inverter applications detailed in this paper.

The first two cases represent separate studies into the use of a grid-forming BESS to stabilise IBR operating in weak grid areas, with both finding that this technology has the potential to stabilise the grid with results comparable to those achieved with a synchronous condenser.

The remaining studies illustrate a range of applications of grid-forming technology within Australia and internationally. Several of these are covered in more detail in the recent G-PST/ESIG webinar 'Survey of Grid-Forming Inverter Applications'<sup>33</sup>, along with other relevant international demonstration projects.

## A1.1 Case Study 1: grid-forming BESS in West Murray region

The West Murray region in the NEM has low system strength and a high concentration of IBR. In 2019, AEMO's detailed electromagnetic transient (EMT) modelling of the region identified that poorly damped sub-synchronous voltage oscillations can occur after a fault in the area followed by a disconnection of a key transmission element. The cause of the oscillations was found to be associated with grid-following IBR in the area. The oscillations were adequately mitigated in 2020 through tuning of the control system parameters of several of these IBR.

In 2020, AEMO and Hitachi ABB collaborated on a desktop study to assess whether a grid-forming BESS might have provided an alternative way to mitigate oscillations in the West Murray region, with the goal of better understanding the capabilities of this technology.

### Advanced inverter applications investigated

To assess the potential of grid-forming inverters to facilitate the **connection of IBR in weak grid areas**, the most onerous contingency was applied to test the effectiveness of a synchronous condenser and an equivalent grid-forming inverter (operating in virtual synchronous machine (VSM) mode) at providing adequate damping to the voltage oscillations.

The example power system shown in Figure 9 was used, with 12 IBR generators, 3 static VAR compensators (SVCs) and one DC interconnector. All IBR generators were simulated using their original configuration settings as they were prior to the 2020 tuning process.

Three cases were investigated:

1. Base case: All IBR generators in service.
2. Base case plus a 60 megavolt-amperes (MVA) synchronous condenser connected at Bus 14.
3. Base case plus A 60 MVA VSM connected at Bus 14.

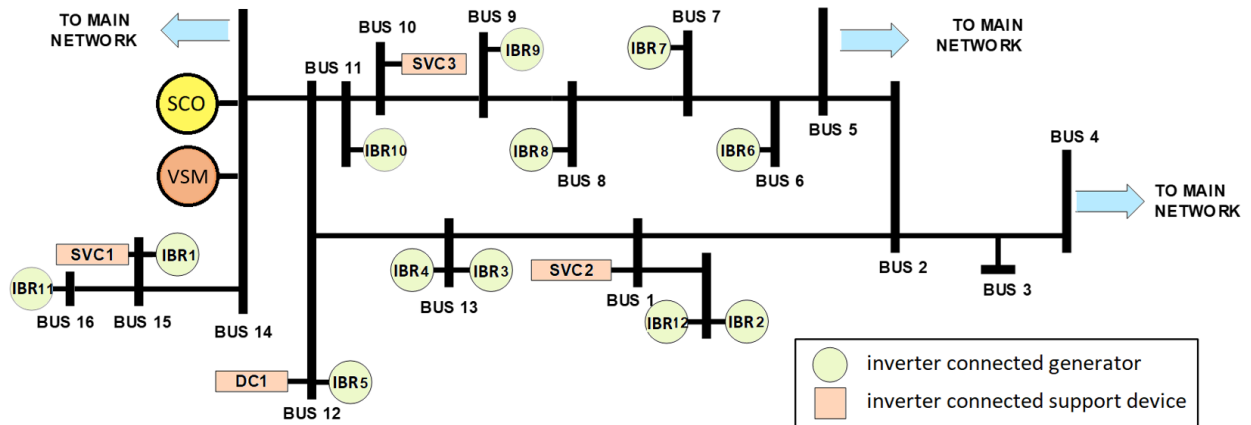
The post disturbance voltages at a given IBR terminal are shown in Figure 10. The base case showed poorly damped voltage oscillations following a disturbance. The peak-to-peak magnitude of oscillation was approximately 0.9% with the frequency of oscillation around 7-8 hertz (Hz) (blue trace). The same disturbance was applied after connecting a 60 MVA synchronous condenser and a 60 MVA VSM at bus 12. For both these cases, the magnitude of oscillations significantly reduced to around 0.3%, showing the similar effectiveness of a synchronous condenser and VSM in providing system strength to the power system and damp voltage oscillations under these conditions.

---

<sup>33</sup> See <https://www.esig.energy/event/g-pst-esig-webinar-series-survey-of-grid-forming-inverter-applications/>

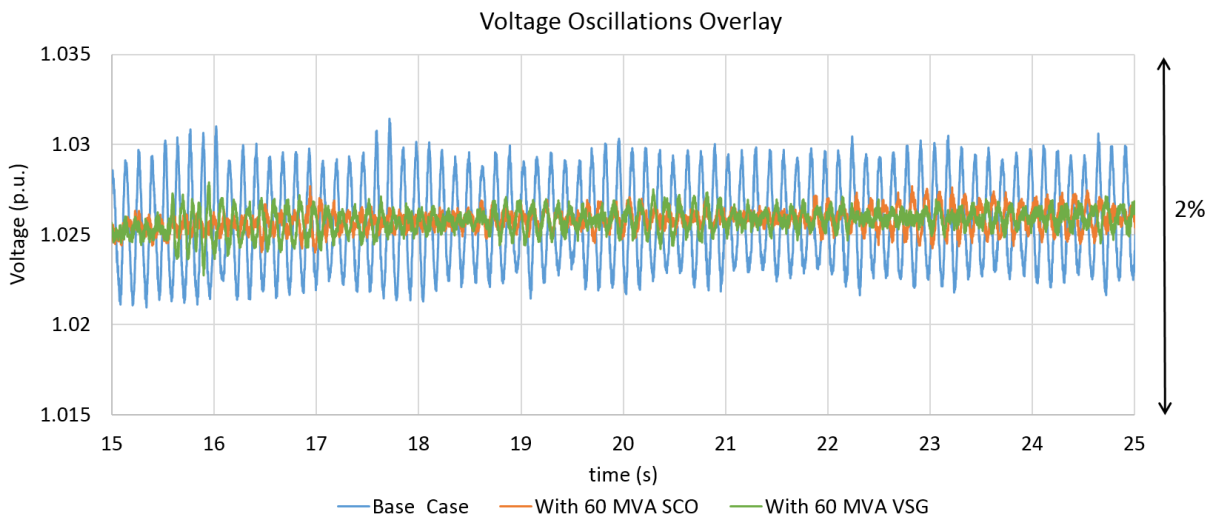


**Figure 9 West Murray region network layout**



SCO: Synchronous condenser

**Figure 10 Post disturbance voltage oscillations for the evaluated three cases**



## A1.2 Case Study 2: grid-forming BESS in Queensland network

In a technical study completed by Powerlink in 2020, EMT modelling was conducted to investigate how a grid-forming inverter BESS, connected in place of a synchronous condenser, could adequately damp sub-synchronous voltage oscillations and improve transient stability in a weak grid area with a high penetration of IBR.

This section provides a brief summary of the findings of this work, as presented at a recent ARENA webinar<sup>34</sup>. The full results of this study are published on the ARENA website<sup>35</sup>.

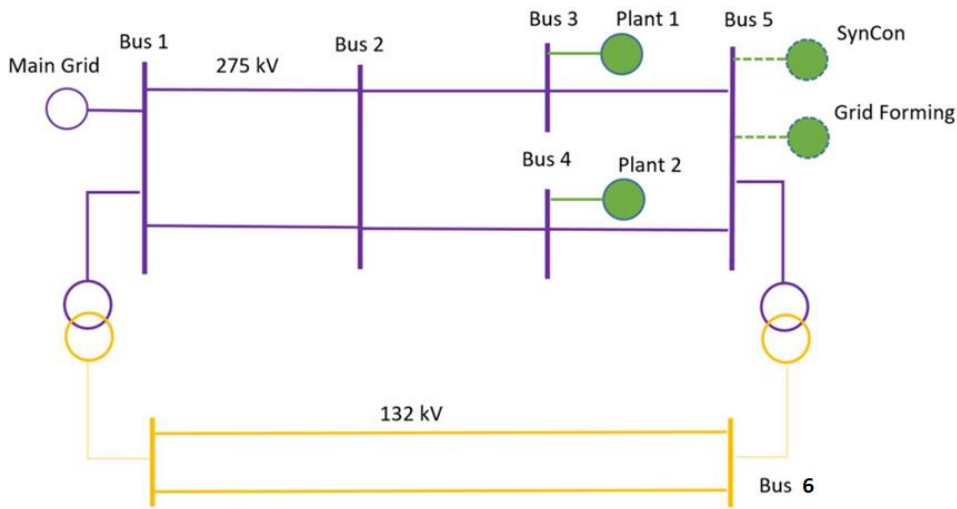
The area of the NEM studied is shown in Figure 11. This network consists of high voltage transmission with two IBR generators connected on single lines at Bus 3 and 4. The buses have been de-identified; however, the study used a section of the real network with some modification. The studied scenarios consisted of:

1. Base Case – only IBR plant 1 and 2 with no synchronous condenser or grid-forming BESS in service.
2. IBR plant 1 and 2 and synchronous condenser only at Bus 5.
3. IBR plant 1 and 2 and grid forming BESS only at Bus 5.

<sup>34</sup> See <https://arena.gov.au/knowledge-bank/presentation-arena-insights-webinar-advanced-inverters/>.

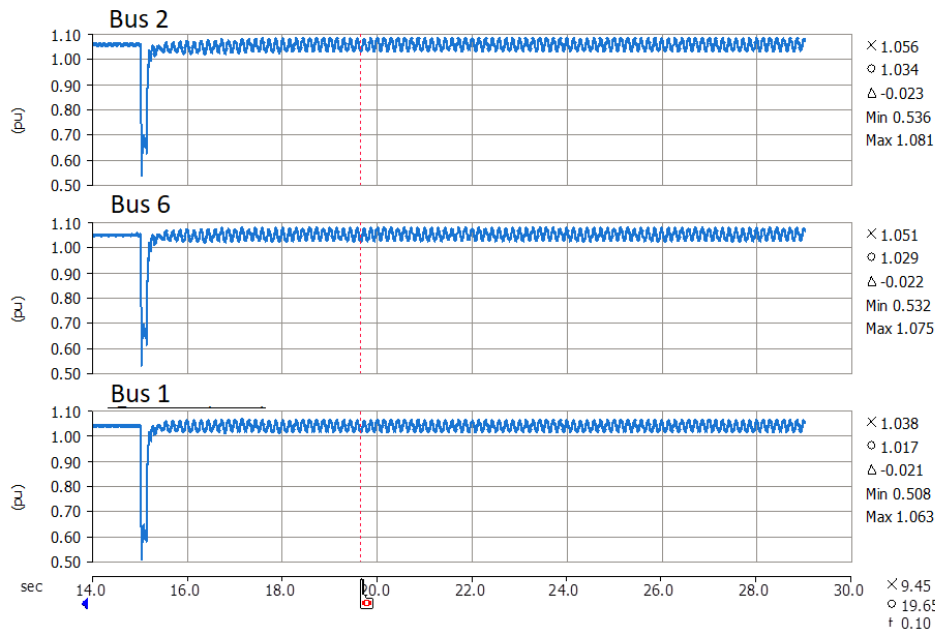
<sup>35</sup> See <https://arena.gov.au/assets/2021/07/pscad-assessment-of-the-effectiveness-of-grid-forming-batteries.pdf>.

**Figure 11 Single line diagram of Powerlink case study network**



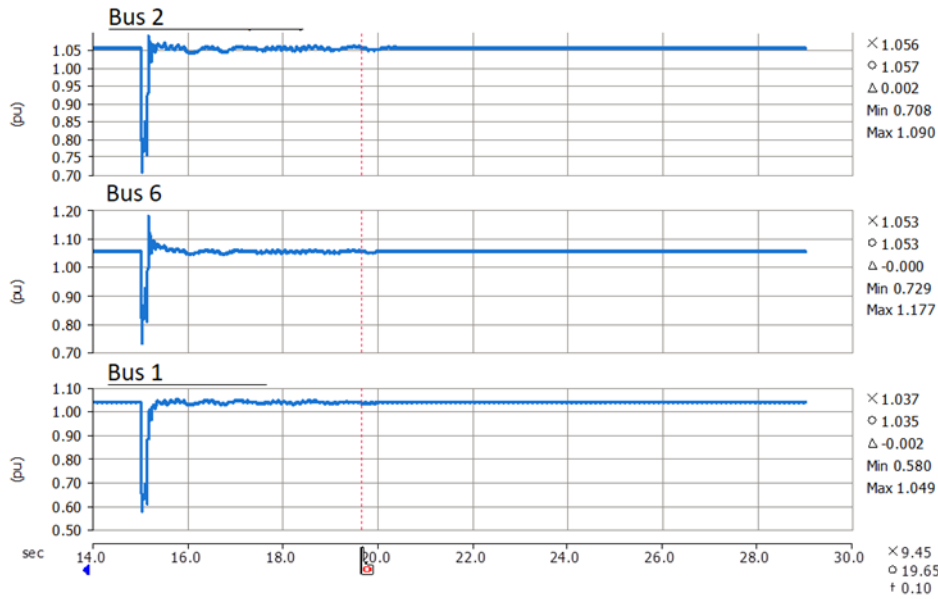
As shown in the ARENA report, after a nearby network fault the base case scenario showed sub-synchronous voltage oscillations from the connected IBR plant reflected at the high voltage buses in the network. The unstable post-fault voltage oscillations are shown in Figure 12. The results show that post-fault (at 15 seconds) the voltage waveform oscillations that occurred were not adequately damped. According to NER S5.2.5.13, S5.1.8(b), and S5.1a.3, the presence of post-fault voltage oscillations that cannot be adequately damped means the network is considered unstable and is a key indicator of a ‘weak grid’.

**Figure 12 Base Case voltage oscillations at each bus post-fault**



Case 2 employed a standard remediation method of increasing system strength by increasing network fault level using an OEM-supplied model of a synchronous condenser at a nearby bus (Bus 5). Figure 13 shows this adequately damped post-fault voltage oscillations.

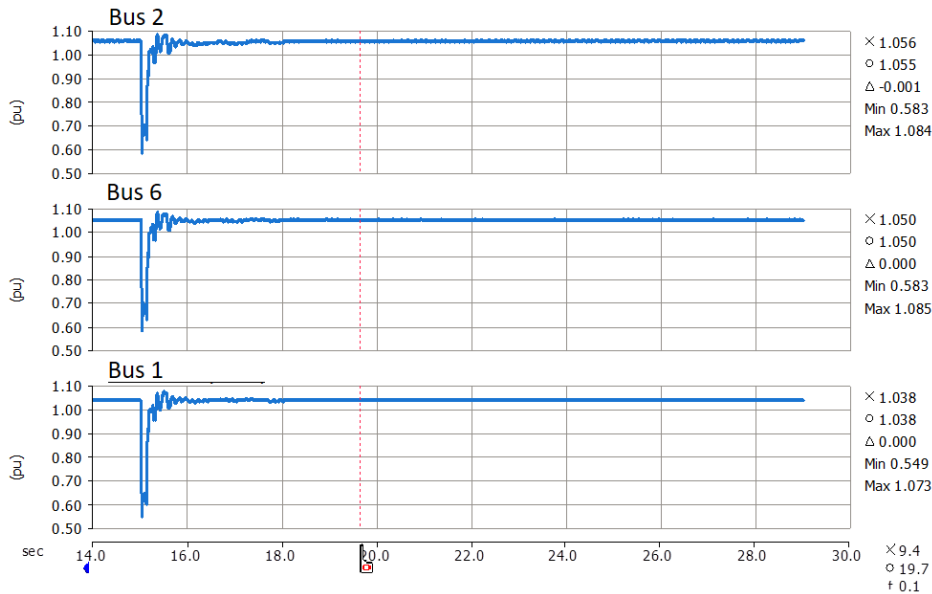
**Figure 13 Case 2 (with synchronous condenser) voltage oscillations at each bus post-fault**



**Advanced inverter applications investigated**

Case 3 used an OEM model of a grid-forming inverter (instead of the synchronous condenser used in Case 2) to show the potential of this technology to provide system strength and **support connecting IBR in weak grid areas**. The grid-forming inverter with a firm battery energy source behind it provided a strong voltage waveform reference for the surrounding grid and provided a damping ability which stabilises the system similarly to the synchronous condenser, as seen in Figure 14.

**Figure 14 Case 3 (with properly tuned grid forming inverter) voltage oscillations at each bus post-fault**

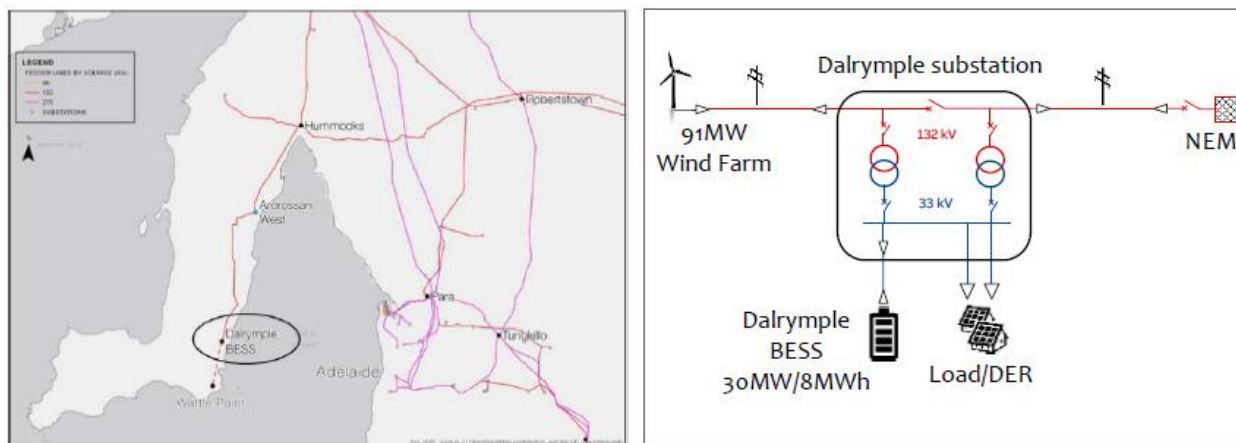


This desktop study indicated that the grid-forming inverter, when placed in an effective position on the network, adequately damped the post-fault voltage oscillations. This damping ability was similar to that exhibited by a synchronous condenser and could enable the stable operation of renewable IBR in the area.

## A1.3 Case study 3: ESCRI battery in grid-forming mode

This case study is adapted from a CIGRE paper by ABB<sup>36</sup> and outlines the capabilities provided by the Dalrymple Energy Storage for Commercial Renewable Integration (ESCRI) BESS in SA. It is currently the largest grid-forming BESS in the world, at 30 MVA and 8 megawatt hours (MWh). It is the first large-scale, grid-forming BESS connected to the NEM. It was installed on the lower Yorke Peninsula in South Australia in 2018, near the end of a long 132 kilovolt (kV) single-circuit radial feeder, as shown in Figure 15.

**Figure 15 ESCRI battery network location – a simple network diagram**



### Advanced inverter applications investigated

The Dalrymple BESS project has shown that grid-forming BESS can provide a range of advanced technical capabilities to support the operation of power systems with high penetration of IBR (as outlined in Section 3).

In the first six months of operation, the Dalrymple BESS reduced the loss of supply in the area from approximately 8 hours to 30 minutes.

The capabilities provided by the project include:

- **Island operation** – the system can operate in islanded configuration and transition to and from an islanded state. When the upstream connection to the transmission system is lost and the system is islanded, it regulates frequency in the microgrid using synthetic inertia, a frequency governor operating in droop mode on the primary control level, and a frequency controller with a small dead-band on the secondary level. Additionally, under islanded conditions, Dalrymple can adjust the system frequency to invoke curtailment of behind-the-meter DER to avoid over-generation conditions.
- **System restart** – the grid-forming BESS can black start the local 33 kV distribution network. This is achieved through a soft energisation of the system (where voltage is ramped up slowly to prevent inrush current and harmonics). However, system restart capability was unproven beyond the small section of local distribution network.
- **Connecting IBR in weak grid areas** – the system can operate at very low Short Circuit Ratios (<1.5), significantly beyond what traditional IBR generation can perform. It is also able to provide system strength support capability via short-term fault current overload.
- **Supporting system security (provision of inertia)** – the BESS can provide adjustable synthetic inertia, rapidly arresting frequency deviations on the grid.

<sup>36</sup> See <https://www.electranet.com.au/wp-content/uploads/2021/02/CIGRE48-Grid-Forming-BESS-Case-Study-August-2020.pdf>.

## A1.4 Case study 4: Wind farm in grid-forming mode

The 69 MW Dersalloch wind farm in Scotland was trialled in grid-forming mode for six weeks during 2019, exploring different tuneable inertia coefficients in its control systems. During the six-week trial, it responded to actual and artificial grid disturbances, including a black start event.

According to Roscoe et al<sup>37</sup>, the wind farm demonstrated responses similar to those expected of a similar sized synchronous generator for all but the largest disturbances. Siemens Gamesa has documented the results of this grid-scale trial, which show a promising future for grid-forming inverters<sup>38</sup>.

### Advanced inverter applications investigated

- **System restart** – the grid-forming wind farm was proven to be able to provide system restart capability, including the ability to black start the local distribution network and a small part of the transmission system. According to the paper, the successful energisation of a 132 kV system and subsequent synchronisation with the grid at 132 kV indicates that renewable generators could play a role in the re-energisation process, potentially bringing distribution customers online faster than a top-down process.
- **Supporting system security (system stability)** – bus decoupling events can cause impedance changes, resulting in a phase step at the generator. When this happens to synchronous machines, the power flow of the machine instantly changes to re-align the phase angle of the generator with that of the grid. This change in power flow helps stabilise the power system. In this case study, a synchronous machine would be expected to provide a burst of power, slowing down its rotor to assist with grid stabilisation. The grid-forming wind farm provided a similar service to that expected of a synchronous machine. By using kinetic energy from the wind turbine blades, the grid-forming inverter was able to provide additional power to the grid and help stabilise the phase step.
- **Supporting system security (provision of inertia)** – on 31 May 2019, the England-France interconnector tripped. The British RoCoF peaked at  $\sim -0.11$  hertz per second (Hz/s) and a frequency drop of  $\sim 0.5$  Hz. The grid-forming wind farm was shown to provide synthetic inertia into the grid, helping arrest frequency. After the interconnector tripped, the turbine output power of the grid-forming wind farm was higher than the inverter reference power, so kinetic energy from the turbine blades was extracted to provide synthetic inertia to the grid.

### The limitations of grid-forming wind turbine generators

The power system events that occurred over the six-week trial were not large enough to have a significant effect on the wind turbine bus voltages, rotor speeds, or pitch angles. This is because the RoCoF and frequency deviations, although significant events, were not large compared to the worst possible deviations which might occur in an islanded power system. To explore the turbines' behaviour under more significant events, artificial disturbances were injected into the control system of the inverter.

The most extreme test involved setting all wind turbines to a high inertia response setting and subjecting them to a 3 Hz frequency drop for a maximum RoCoF of  $-1$  Hz/s at 12:05pm. In this test, the kinetic energy extracted from the turbines to provide synthetic inertia (Figure 16a) the grid significantly reduced the rotor speed.

As the event progressed, this reduction in rotor speed led to a reduction in the power generated by the turbines and also left the turbines with a post-event recovery period (Figure 16b) where power output was reduced until the rotor speeds recovered.

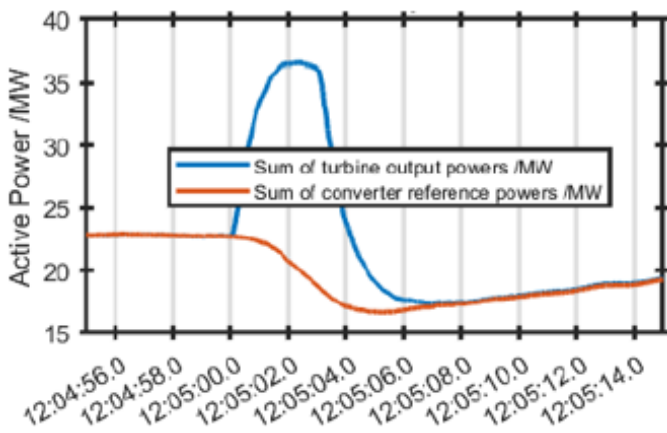
---

<sup>37</sup> "Response of a grid forming wind farm to system events, and the impact of external and internal damping", Roscoe A., Kneuppel T., Da Silva R., Brogan P., Gutierrez I., Elliott D., Perez Campion J., IET Journals, published 2021, at <https://ietresearch.onlinelibrary.wiley.com/doi/epdf/10.1049/iet-rpg.2020.0638>.

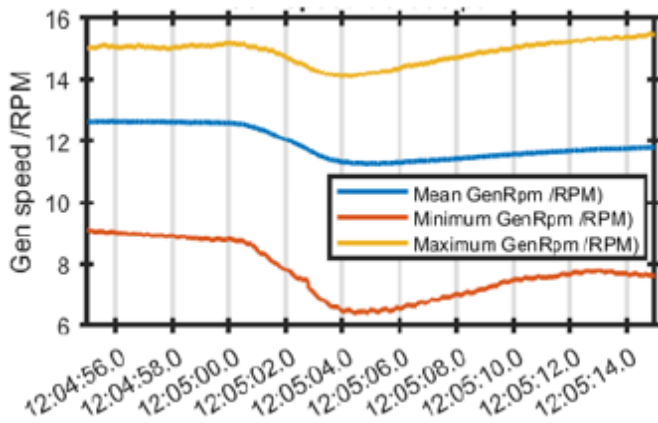
<sup>38</sup> "Operator Considerations for the Implementation of Testing Enhanced Grid Forming Services on an Onshore Wind Park", Gutierrez et al, Virtual 19th Wind Integration Workshop, 11-12 November 2020.

**Figure 16 Active power and rotor speed diagrams in response to a major RoCoF event**

**Panel a: Active power output of wind generator (blue trace) in response to system disturbance (orange trace)**



**Panel b: Maximum, mean, and minimum wind turbine rotor angle speeds before and after its response to the system disturbance**



Source: “Response of a grid forming wind farm to system events, and the impact of external and internal damping”, Roscoe et al, at <https://ietresearch.onlinelibrary.wiley.com/doi/epdf/10.1049/iet-rpg.2020.0638>.

This event demonstrated that there are limits to the grid support that can be provided by wind turbines without additional energy storage. Energy storage would firm the wind farm’s response over a wider range of operating conditions, however this would add additional capital costs.

## A1.5 Case study 5: HVDC station in grid-forming mode

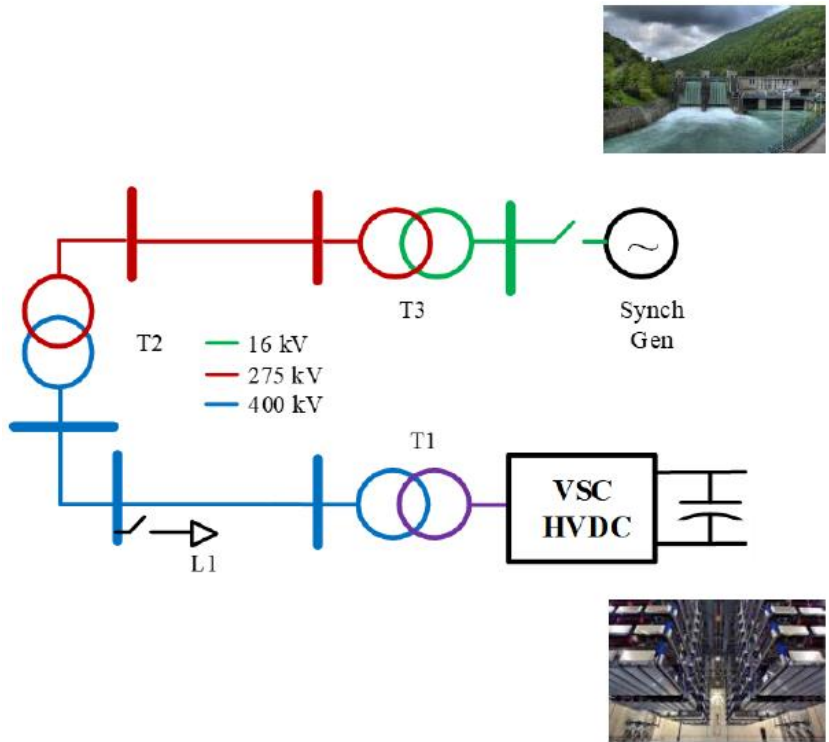
An EPRI presentation from February 2020<sup>39</sup> summarises a black start simulation, using a 1,400 MW voltage-source converter HVDC between Norway and Scotland to successfully restore sections of the Scottish Grid.

The study case, simulated in EMT software, began with energisation of the HVDC station on the Scottish side, which then energised surrounding distribution networks, eventually picking up a synchronous pumped hydro station to complete the rest of the system restart services.

Figure 17 shows the network layout used in the simulation.

<sup>39</sup> At [https://www.hvdccentre.com/wp-content/uploads/2020/02/EPRI-HVDC-Restoration-Project-Final-Webinar\\_20200213.pdf](https://www.hvdccentre.com/wp-content/uploads/2020/02/EPRI-HVDC-Restoration-Project-Final-Webinar_20200213.pdf).

Figure 17 Simplified network diagram of black starting a hydro generator with HVDC

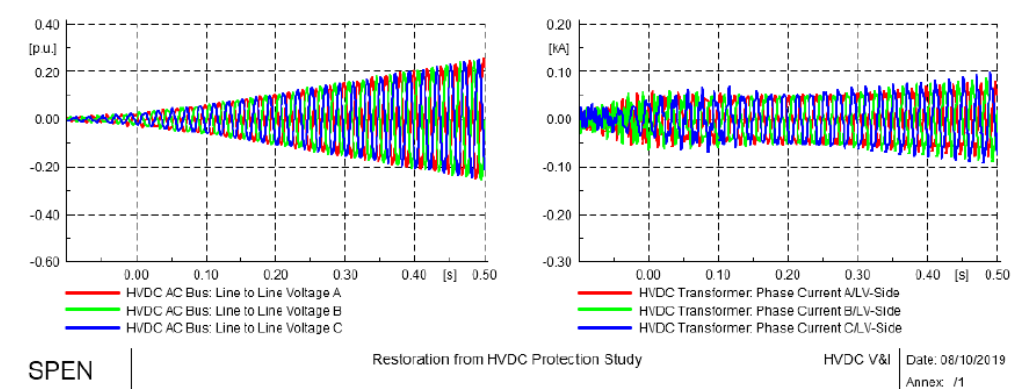


### Advanced inverter applications investigated

The **system restart** capability was simulated using a soft energisation of the system, where voltage is ramped up slowly to prevent inrush current and harmonics. Soft starting increases the prospect of successful restoration by reducing the probability of protection tripping due to overcurrent, and additionally can aid in preventing switching and harmonic overvoltage. The phasor diagrams in Figure 18 show how the HVDC station ramps up the voltage from 0 to 1 pu alongside the resulting energisation of the network transformers.

The HVDC station was configured in grid-forming mode during the initial restoration process, and once the synchronous grid was established with the operation of the hydro generator, the HVDC returned to grid-following mode.

Figure 18 Phasor diagram of the HVDC soft energisation current over 0.5 seconds



### **The limitations of grid forming for system restart**

This case study showed that grid-forming inverters on an HVDC station have the potential to energise into the transmission network during a system restart. However, this capability relies on the high power and energy sources on the other end of the HVDC connection. Other applications of grid-forming inverters (such as batteries) may not have such a large capacity available, so may be limited in their capability to restart large networks.

Soft starting shows potential as a means of managing current flows during energisation of a section of the system. However, as the system restart process progresses to sequentially include other generators and network infrastructure, it may become challenging to manage voltages within the limits of these assets during a soft start.