



Draft Transmission Cost Report

May 2021

Draft report for consultation

For the Integrated System Plan (ISP)

Important notice

PURPOSE

AEMO publishes this Draft *Transmission Cost Report* as part of an initiative to improve the accuracy and transparency of transmission costs used for the 2022 ISP. The final 2021 Inputs, Assumptions and Scenarios Report will include the updated transmission costs.

DISCLAIMER

AEMO has made all reasonable efforts to ensure the quality of the information in this publication but cannot guarantee that information, forecasts and assumptions are accurate, complete or appropriate for your circumstances. This publication does not include all of the information that an investor, participant or potential participant in the National Electricity Market (NEM) might require, and does not amount to a recommendation of any investment.

Anyone proposing to use the information in this publication (which includes information and forecasts from third parties) should independently verify its accuracy, completeness and suitability for purpose, and obtain independent and specific advice from appropriate experts. Accordingly, to the maximum extent permitted by law, AEMO and its officers, employees and consultants involved in the preparation of this document:

- make no representation or warranty, express or implied, as to the currency, accuracy, reliability or completeness of the information in this document; and
- are not liable (whether by reason of negligence or otherwise) for any statements or representations in this document, or any omissions from it, or for any use or reliance on the information in it.

VERSION CONTROL

Version	Release date	Changes
1.0	28/5/2021	Initial release

© 2021 Australian Energy Market Operator Limited. The material in this publication may be used in accordance with the copyright permissions on AEMO's website.

Contents

1.	Introduction	5
1.1	Notice of consultation	5
1.2	Previous and scheduled consultation on transmission costs	7
1.3	Broader ISP processes and consultation	7
1.4	Application of transmission cost estimates in the ISP	10
2.	Methodology	13
2.1	Cost estimate development stages	13
2.2	<i>Transmission Cost Database</i>	15
2.3	Review of TNSP cost estimates	20
2.4	Estimating operational expenditure	22
3.	Flow paths	23
3.1	Overview	23
3.2	Legend and explanation of tables	26
3.3	Central and North Queensland to Gladstone Grid	28
3.4	Southern Queensland to Central & North Queensland	29
3.5	Northern New South Wales – Southern Queensland	30
3.6	Central New South Wales to Northern New South Wales	32
3.7	Central New South Wales to Sydney, Newcastle and Wollongong	33
3.8	Southern New South Wales to Central New South Wales	35
3.9	Victoria to Southern New South Wales	37
3.10	Tasmania to Victoria	40
3.11	New South Wales to South Australia	41
4.	Renewable energy zones	42
4.1	Overview	42
4.2	New South Wales	44
4.3	Queensland	54
4.4	South Australia	70
4.5	Tasmania	80
4.6	Victoria	84
5.	Generator connection costs	94
5.1	Connection costs	94
5.2	System strength remediation costs	97
A1.	Cost classification checklist	98

Tables

Table 1	Related files and reports	6
Table 2	Previous and scheduled consultation on transmission costs for the 2022 ISP	7
Table 3	Committed and anticipated transmission projects for the 2022 ISP	11
Table 4	RIT-T projects in the ISP	11
Table 5	Preparatory activities	12
Table 6	Indicative ISP project development stages	14
Table 7	<i>Transmission Cost Database</i> calculation sequence	19
Table 8	Example estimate adjustment	21
Table 9	Connection costs for solar, wind, and solar thermal generation technologies	95
Table 10	Connection costs for other generation technologies (excluding batteries) [†]	96
Table 11	Connection costs for batteries	96
Table 12	System strength remediation options	97

Figures

Figure 1	Timeline for Transmission Cost consultation	5
Figure 2	Parallel ISP consultations	8
Figure 3	Navigating the ISP process	9
Figure 4	AEMO's approach to incorporating transmission projects in the IASR	10
Figure 5	Design progress with project maturity – example showing how overhead line length assumption changes	14
Figure 6	Cost estimate summary breakdown from Class 5 to Class 1	17
Figure 7	Cost breakdown structure	18
Figure 8	Flow path development options	25
Figure 9	Candidate renewable energy zones	43
Figure 10	Connection cost representation	94

1. Introduction

AEMO's *Integrated System Plan (ISP)* is a whole-of-system plan that provides an integrated roadmap for the efficient development of the National Electricity Market (NEM) over the next 20 years.

AEMO considers that leveraging expertise from across the industry is pivotal to the development of a robust plan that supports the long-term interests of energy consumers. As part of the 2022 ISP development process, AEMO is focusing on improving transparency and stakeholder engagement on a range of areas, including improving transmission cost estimation. Accurate cost estimates are a vital component of the process to determine whether transmission projects should proceed.

This *Draft Transmission Cost Report* forms part of the *2021 Inputs, Assumptions and Scenarios Report (IASR)*. It describes the engagement of independent experts and provision of industry advice, culminating in publishing the draft report, which presents a summary of the design, capacity and cost estimate for candidate transmission projects for the 2022 ISP. As part of the actionable ISP rules, AEMO has asked Transmission Network Service Providers (TNSPs) to provide detailed estimates for some projects (see Section 1.4).

AEMO is now seeking further feedback on our proposed approach to transmission cost estimation for the 2022 ISP and on our Transmission Cost Database.

1.1 Notice of consultation

Invitation for written submissions on the Draft Transmission Cost Report

All stakeholders are invited to provide a written submission to any matters discussed in the *Draft Transmission Cost Report*. Submissions need not address all areas or questions.

Submissions should be sent via email to ISP@aemo.com.au and are required to be submitted by Friday 25 June 2021.

All submissions should be provided in PDF format. Please identify any parts of your submission that you wish to remain confidential and explain why. AEMO requests that, where possible, submissions should provide evidence and information to support any views or claims that are put forward. Feedback is welcome on this report and the accompanying *Transmission Cost Database*. The timeline for consultation on transmission costs is shown in Figure 1 below.

Figure 1 Timeline for Transmission Cost consultation

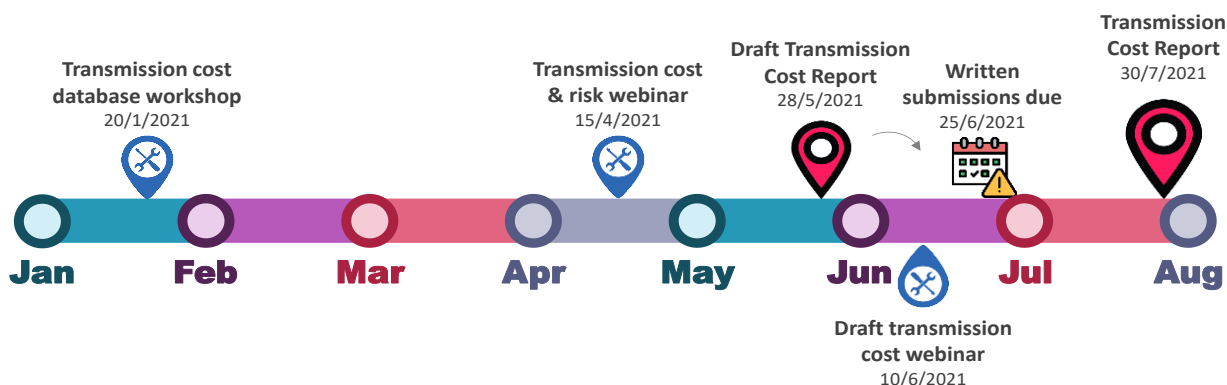

Consultation questions

Stakeholders are invited to make a written submission on any matter they consider relevant to the *Draft Transmission Cost Report*. AEMO would particularly welcome submissions on the following questions.

Your views on AEMO's approach to the transmission cost estimation process

- Are there any factors not currently assessed that AEMO should consider in its method for estimating the costs of future transmission projects in the ISP?
- Are there any other aspects AEMO should consider for risk assessments when estimating costs of future transmission projects in the ISP?
- What, if any, modifications should AEMO consider to the *Transmission Cost Database*?
- Are there any other factors AEMO should consider in its approach to reviewing cost estimates submitted by TNSPs?

Your views on the flow path augmentation and renewable energy zone (REZ) development options

- Has AEMO considered the most appropriate flow path augmentation options? If not, what else should AEMO consider?
- Has AEMO considered the most appropriate options for expanding transmission access in REZs? If not, what else should AEMO consider?
- What, if any, additional factors should AEMO consider when identifying network augmentation options?

Your views on generator connection costs

- Has AEMO considered all the relevant factors in estimating costs of connection of generator projects? If not, what else should AEMO consider?

Supplementary materials

Table 1 below outlines related files and reports that have been used to determine transmission costs for the 2022 ISP. Stakeholders are invited to refer to these documents for further background and context.

Table 1 Related files and reports

Document	Description	Location
<i>Transmission Cost Database</i>	Database of cost estimate inputs and cost estimating tool used for Future ISP projects.	https://www.aemo.com.au/consultations/current-and-closed-consultations/Transmission-costs-for-the-2022-Integrated-System-Plan
<i>Transmission Cost Database User Manual</i>	Describes how to use the <i>Transmission Cost Database</i> .	
<i>Transmission Cost Database Consultant's Report</i>	Report documenting the construction and benchmarking of the <i>Transmission Cost Database</i> .	
<i>Draft Transmission Cost Estimate Calculations</i>	A compressed ZIP file containing <i>Transmission Cost Database</i> output files for each project option. These records show the makeup of AEMO's transmission cost estimates – including building blocks, adjustments, risk and indirect costs.	

Next steps

AEMO will undertake a review of submissions received on the *Draft Transmission Cost Report*, and will hold a webinar on 10 June 2021 to provide further opportunity for stakeholders to give feedback and ask questions.

The final *Transmission Cost Report* will be published alongside the 2021 IASR on 30 July 2021 and will take into account views from the June webinar and submissions received as part of the written consultation process.

1.2 Previous and scheduled consultation on transmission costs

In response to feedback on the 2020 ISP, AEMO began an initiative to improve the accuracy and transparency of transmission costs used for the 2022 ISP. The consultation process on the *Draft Transmission Cost Report* aims to provide stakeholders with a full and transparent explanation of the transmission costs AEMO proposes to use in the 2022 ISP, including the underlying cost building block data, approach to risk, and assumptions used to generate the estimates. The previous and scheduled consultation on transmission costs for the 2022 ISP are shown in the following table.

Table 2 Previous and scheduled consultation on transmission costs for the 2022 ISP

Description	Timeframe	Status
Tender and engagement of expert consultant	October – November 2020	Complete
TNSP and AER engagement	December 2020	Complete
Stakeholder workshop to review the proposed design of the Transmission Cost Database	20 January 2021	Complete
Consultant developed Transmission Cost Database	January - April 2021	Complete
Transmission cost and risk webinar used to inform approach to risk in transmission cost estimation	15 April 2021	Complete
AEMO developed transmission cost estimates with review from TNSPs	April 2021 – May 2021	Complete
<i>Draft Transmission Cost Report</i> and Transmission Cost Database published	28 May 2021	Complete
<i>Draft Transmission Cost Report</i> consultation	28 May – 25 June 2021	Ongoing
Webinar on draft transmission costs	10 June 2021	Scheduled
TNSPs provide costs for future projects with preparatory activities and current actionable projects †	30 June 2021	Scheduled
AEMO review of TNSP estimates	July 2021	Scheduled
Publication of 2021 IASR with accompanying transmission cost report	30 July 2021	Scheduled

† AEMO reserves the right to add offsets to prices advised by TNSPs to ensure that uncertainty and risks are applied consistently across investment options.

1.3 Broader ISP processes and consultation

2022 ISP publications to date

The *Draft Transmission Cost Report* is a component of the IASR consultation for the 2022 ISP. This report and its consultation were pre-empted in the Draft 2021 IASR; under the Australian Energy Regulator's (AER's) Forecasting Best Practice Guidelines, the IASR may pre-empt consultation on topics that are not ready at the time of the Draft IASR.

AEMO has previously published:

- The **2022 ISP Timetable** in October 2020, providing a high-level overview of the key milestones related to the 2022 ISP and allowing stakeholders to understand and engage in the ISP consultation process.
- The **Draft IASR** in December 2020, proposing the scenarios to be used, as well as detailing current inputs and assumptions in relation to a variety of considerations for use in the 2022 ISP, including the approach for updating current assumptions for use in the proposed scenarios. Before the Draft IASR was published, multiple stakeholder engagements had taken place to inform the content, including workshops and webinars. The publication of the Draft IASR began a consultation process with stakeholders, which is currently in progress, on these scenarios and their inputs.
- The **ISP Methodology Issues Paper** in February 2021 and **Draft ISP Methodology** in May 2021. The draft set out the proposed methodologies to determine potential development paths (sequences of projects) in the ISP and to test alternative development paths and determine an optimal development path.

2022 ISP ongoing consultations

Figure 2 below shows the status of the main ISP consultations. Before developing and consulting on the Draft 2022 ISP, AEMO is required to:

- Consult on inputs, assumptions and scenarios.
 - AEMO received nearly 50 submissions to the Draft IASR. Following a submission webinar in March 2021, a series of Forecasting Reference Group (FRG) meetings, and this consultation on transmission costs, AEMO plans to release the 2021 IASR on 30 July 2021.
- Consult on the ISP methodology.
 - AEMO published the *ISP Methodology Issues Paper* in February 2021, and then a *Draft ISP Methodology* in April 2021. AEMO plans to release the *Final ISP Methodology* on 30 July 2021.

Figure 2 Parallel ISP consultations

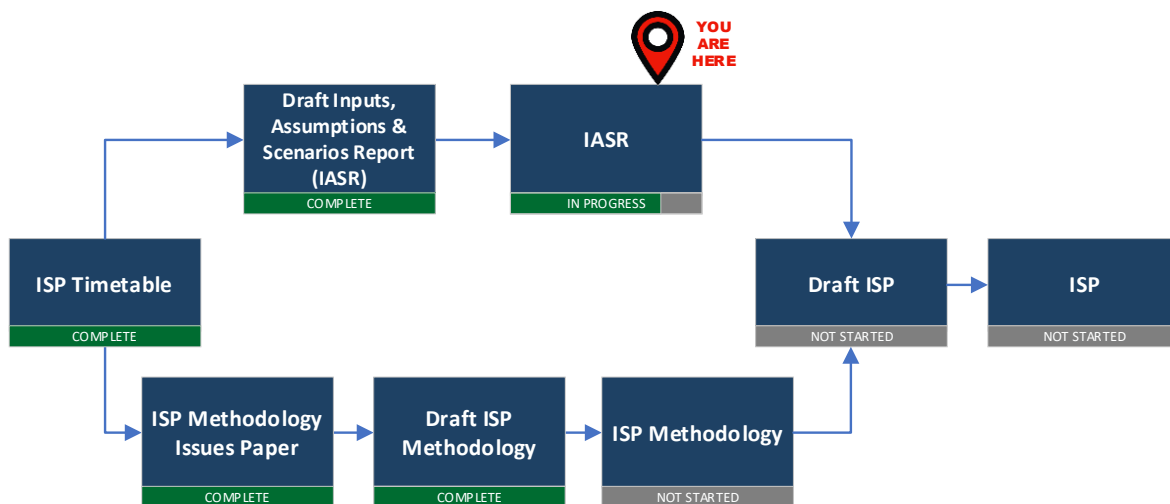

† The Draft Transmission Cost Report is a component of the IASR consultation.

Figure 3 below shows the ISP process as a whole, noting current progress on all elements.

Figure 3 Navigating the ISP process

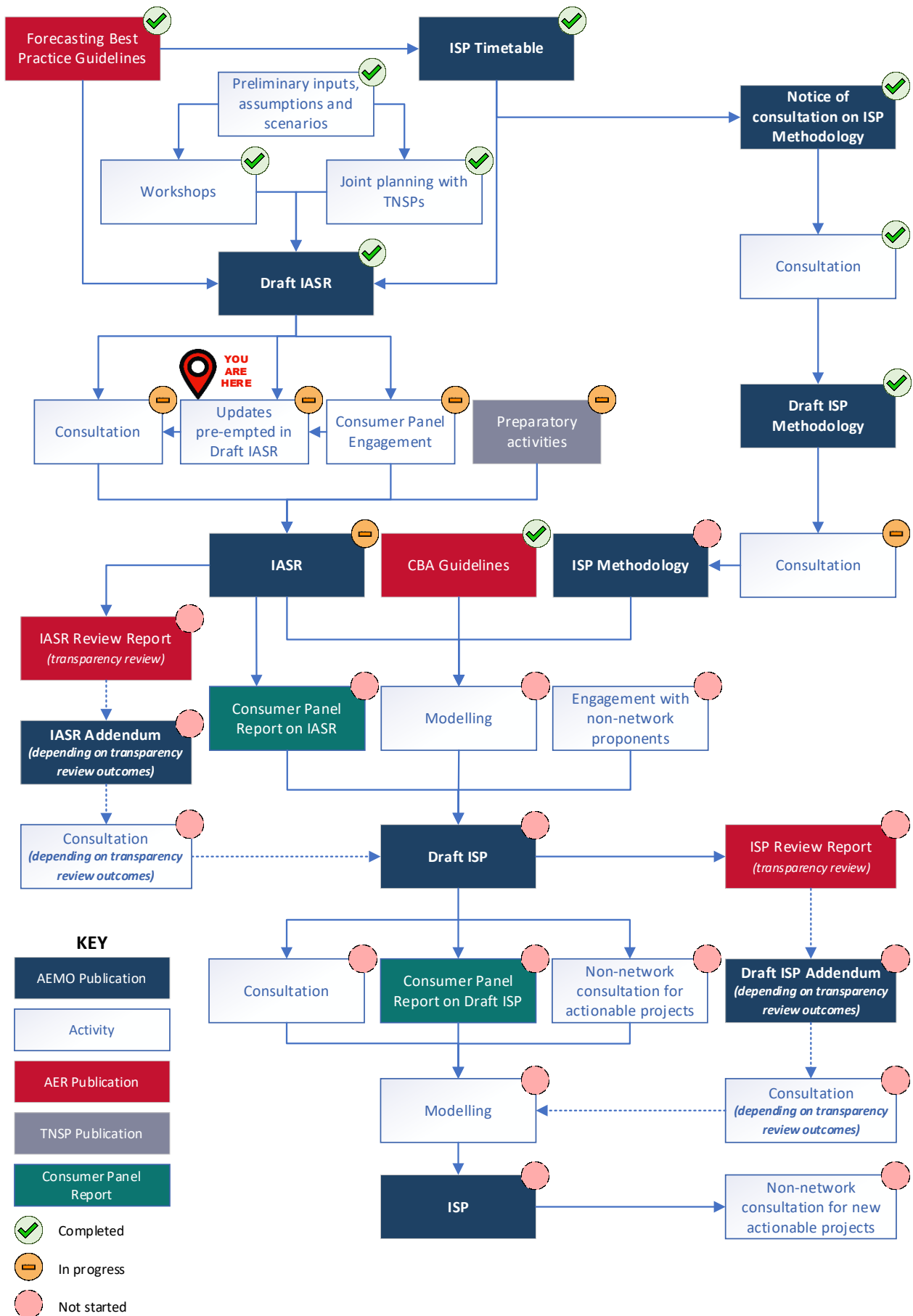

1.4 Application of transmission cost estimates in the ISP

AEMO’s approach to incorporating cost estimates in the ISP is illustrated in Figure 4 below. TNSPs are required to provide estimates and initial designs for “Future ISP projects with Preparatory Activities” or projects undergoing the Regulatory Investment Test for Transmission (RIT-T) process by 30 June 2021. AEMO will then cross-check this information using the *Transmission Cost Database* before it is included in the final 2021 IASR. All other projects not costed by TNSPs are estimated by AEMO using the new *Transmission Cost Database*. The *Transmission Cost Database* provides suitable risk margins at the early stages of a proposed project to allow for the large amount of known but as yet unquantified risks, and potential additional costs (currently unknown) that may arise in later stages of a proposed project.

Figure 4 AEMO’s approach to incorporating transmission projects in the IASR

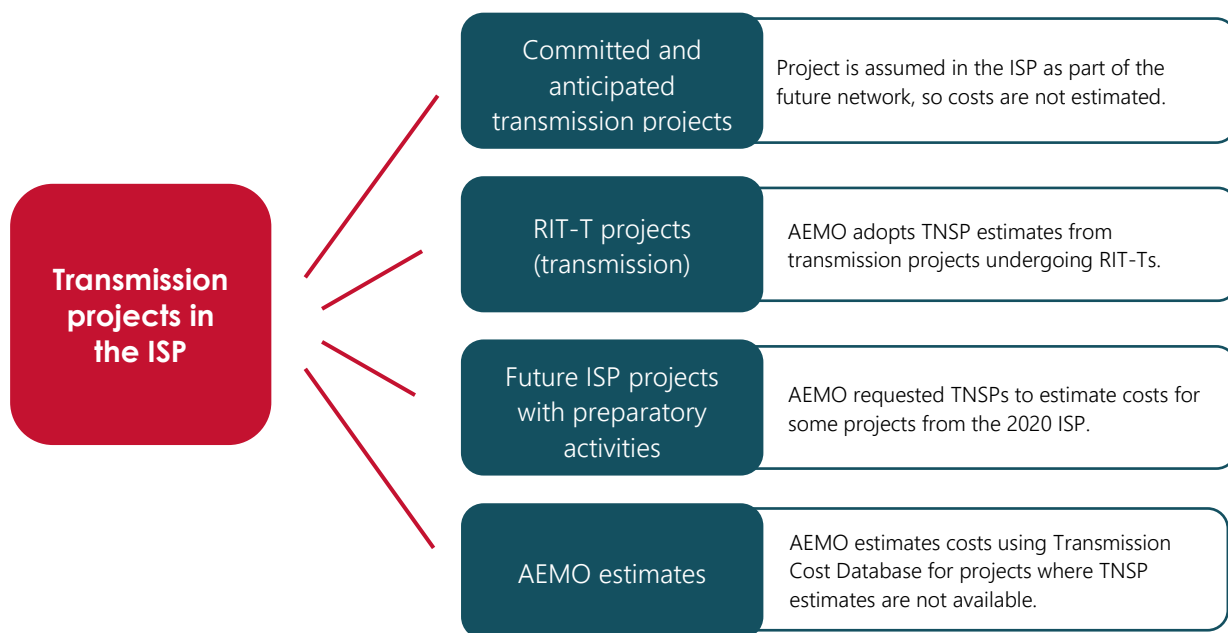

Committed and anticipated projects

The CBA Guidelines (and the RIT-T Instrument¹) define five criteria that must be used to assess the commitment status of projects:

- If the project has satisfied all five criteria, it is defined as a committed project.
- If the project is in the process of meeting at least three of the criteria, it is defined as an anticipated project.

AEMO includes all committed and anticipated projects in all future states of the world, in accordance with the AER’s CBA Guidelines². Because these projects are assumed to proceed, the project cost is not considered in the ISP.

The following projects are classified as committed or anticipated transmission projects.

¹ See <https://www.aer.gov.au/system/files/AER%20-%20Regulatory%20investment%20test%20for%20transmission%20-%202025%20August%202020.pdf>.

² At <https://www.aer.gov.au/system/files/AER%20-%20Cost%20benefit%20analysis%20guidelines%20-%202025%20August%202020.pdf>.

Table 3 Committed and anticipated transmission projects for the 2022 ISP

Project	Status	Responsible TNSP(s)	More information
Central West Orana REZ Transmission Link	Anticipated †	TransGrid	https://energy.nsw.gov.au/renewables/renewable-energy-zones ; Section 4.2.3 of this report.
Eyre Peninsula Link	Committed	ElectraNet	https://www.electranet.com.au/projects/eyre-peninsula-link/
Project EnergyConnect	Anticipated ‡	ElectraNet and TransGrid	https://www.projectenergyconnect.com.au/ ; Section 3.11 of this report.
Queensland to New South Wales Interconnector (QNI) Minor	Committed	Powerlink and TransGrid	https://www.powerlink.com.au/expanding-nsw-qld-transmission-transfer-capacity ; https://www.transgrid.com.au/qni
Victoria to New South Wales Interconnector (VNI) Minor	Committed	AEMO (Victorian TNSP) and TransGrid	https://www.transgrid.com.au/vni ; https://aemo.com.au/en/initiatives/major-programs/victoria-to-new-south-wales-interconnector-upgrade-regulatory-investment-test-for-transmission
VNI System Integrity Protection Scheme (SIPS)	Committed	AEMO (Victorian TNSP)	https://aemo.com.au/-/media/files/electricity/nem/planning_and_forecasting/vapr/2020/2020-vapr.pdf
Western Victoria Transmission Network Project	Anticipated	AEMO (Victorian TNSP)	https://www.westvictnp.com.au/

† The Central West Orana REZ Transmission Link is currently at an advanced stage of consultation and planning, and is expected to be shovel ready by the end of 2022. Following the legislation of the *NSW Electricity Infrastructure Investment Act*, this is now considered to be an anticipated project for the purpose of the 2022 ISP.

‡ If the Contingent Project Applications³ for Project EnergyConnect are not approved, AEMO will model this project as an augmentation option rather than a “committed” or “anticipated” project. See Section 3.11 for more information on this project.

RIT-T cost estimates

AEMO requested cost estimates and augmentation information from TNSPs for projects currently being assessed under the RIT-T. Because these projects remain highly uncertain, they are modelled as augmentation options in the ISP (that is, they are not assumed to proceed). AEMO considers that TNSPs are best placed to estimate the cost of these projects. To ensure consistency across regions, AEMO reserves the right to add offsets to prices advised by TNSPs to ensure uncertainty and risks are applied consistently across investment options.

Table 4 RIT-T projects in the ISP

Project	Responsible TNSP	Section in this report
HumeLink	TransGrid	Section 3.8
Improving stability in south-western NSW	TransGrid	Section 4.2.5
Marinus Link	TasNetworks	Section 3.10
VNI West	AEMO (Victorian TNSP) and TransGrid	Section 3.9

³ AER, *TransGrid and ElectraNet – Project EnergyConnect contingent project*, at <https://www.aer.gov.au/networks-pipelines/determinations-access-arrangements/contingent-projects/transgrid-and-electranet-%E2%80%93-project-energyconnect-contingent-project>.

Preparatory activities

As part of the actionable ISP rules, AEMO has asked TNSPs to provide a report on preparatory activities for future ISP projects. These are transmission projects that may become actionable ISP projects, but about which more detailed information – such as improved cost estimates, network designs, and initial appraisal of land considerations – is required.

Please note that preparatory activities are not the same as early works leading to final investment decision (FID), and preparatory activities remain essentially a desktop exercise.

Further, the initial high-level design and costing provided in the preparatory activities report is approximate, because detailed requirements for robust costings and plant design will not have been undertaken. This would require much more extensive work, including detailed Geotech land surveying and engagement on the route and necessary planning approvals.

The projects for which preparatory activities are currently required to be performed by TNSPs are outlined in the following table.

Table 5 Preparatory activities

Project	2020 ISP Timing	Preparatory activities required by	Responsible TNSP(s)	Section(s) in this report
Gladstone Grid Reinforcement	2030s	30 June 2021	Powerlink	Section 3.3
Central to Southern Queensland Transmission Link	Early 2030s	30 June 2021	Powerlink	Section 3.4
QNI Medium and Large	2032-33 to 2035-36	30 June 2021	Powerlink and TransGrid	Sections 3.5 and 3.6
Reinforcing Sydney, Newcastle and Wollongong Supply	2026-27 to 2032-33	30 June 2021	TransGrid	Section 3.7
North West NSW REZ Network Expansion	2030s, based on connection interest	30 June 2021	TransGrid	Section 4.2.1
New England REZ Network Expansion	2030s	30 June 2021	TransGrid	Section 4.2.2

AEMO's cost estimates

There are many transmission projects assessed in the ISP where TNSPs have not developed augmentation options and cost estimates. For these projects, AEMO determines and consults on augmentation options and cost estimates. This process started in December 2020, where AEMO consulted on augmentation corridors in the Draft 2021 IASR⁴. This draft report outlines options to augment these corridors. The augmentation options are split into two main groups:

- **Flow paths** – the portion of the transmission network used to transport significant amounts of electricity across the backbone of the interconnected network to load centres – see Section 3.
- **REZs** – the network required to connect renewable generation in areas where clusters of large-scale renewable energy can be developed using economies of scale – see Section 4.

⁴ At <https://aemo.com.au/consultations/current-and-closed-consultations/2021-planning-and-forecasting-consultation-on-inputs-assumptions-and-scenarios>.

2. Methodology

In response to feedback from stakeholders, AEMO initiated a work program after the 2020 ISP to improve the transparency and robustness of the transmission cost estimation process used for subsequent ISPs. This included an update to the cost estimation methodology that enhances the approach for incorporating risk, and preparation of a new *Transmission Cost Database* which is used to estimate the cost of transmission projects. The process used to estimate transmission project costs is outlined in the following sections, along with a proposal to ensure consistency with TNSP project estimates.

This section describes the following aspects:

- The development stages of cost estimates, which become more detailed and accurate as a project progresses.
- The *Transmission Cost Database* – used for AEMO estimates.
- TNSP estimates, which describes how AEMO reviews estimates from TNSPs to ensure consistency and appropriateness for the ISP.

2.1 Cost estimate development stages

Cost estimates progress from a very early stage with little design or information known (least accurate) to a fully costed and engineered estimate built up over years (most accurate).

In the early stages, allowances are used to account for the fact that the work scope is not well defined, project approvals have not yet been obtained, and component costs may not be market-tested. As projects mature and the scope of works is further defined, more of the cost is assigned to the base estimate, reducing the size of allowances for risks and uncertainties.

The AACE International classification system is commonly used in many industries for defining the level of accuracy of a cost estimate, based on the amount of design work that has been done. AEMO has adopted the AACE framework in its cost estimate methodology to classify cost estimates.

Figure 5 shows how the definition of a single parameter within an estimate (using the example of transmission overhead line length) is progressed as a project matures from a Class 5 to Class 2 or 1 within the AACE framework.

It is important to note that this process does not rely on a linear maturation of the scope of works; rather Class 5 (the earliest stage) relies on significantly less inputs than what would be required for Class 4 or Class 3.

The development of the *Transmission Cost Database* has helped to refine AEMO's approach to cost estimation, and has informed the definition of the work needed across each stage of development. Table 6 shows the current stages for ISP projects and outlines the planning and development works that typically take place at each stage. The indicative class levels shown here reflect AEMO's current understanding of levels typically used at each stage, which may vary across the TNSPs and across projects. AER guidelines⁵ outline the expectations for each stage of the RIT-T, however they do not currently stipulate a specific class level for cost estimates, as estimate accuracy achieved at each stage will depend on the nature of the project.

⁵ At <https://www.aer.gov.au/system/files/AER%20-%20Regulatory%20investment%20test%20for%20transmission%20application%20guidelines%20-%2025%20August%202020.pdf>.

Figure 5 Design progress with project maturity – example showing how overhead line length assumption changes

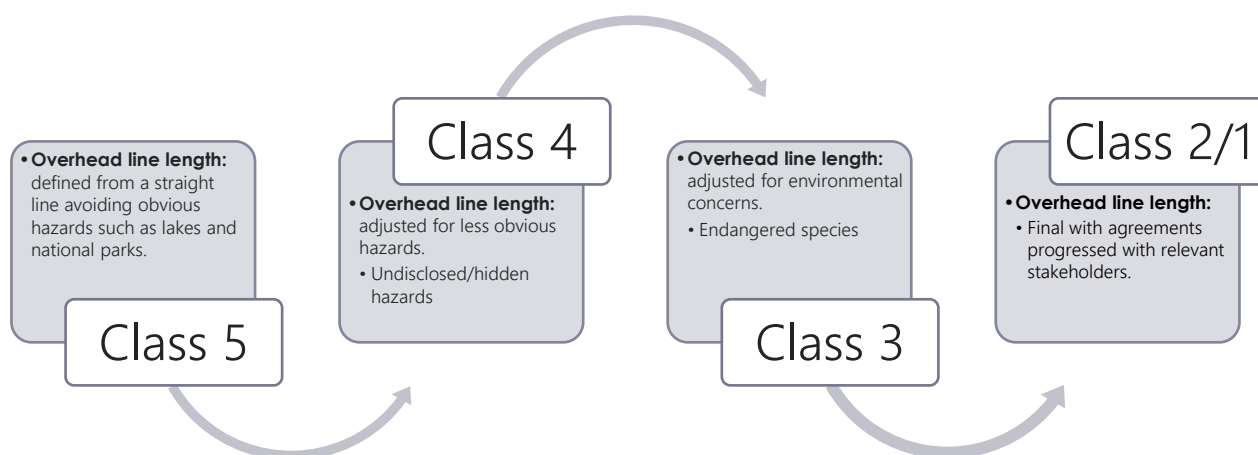

Table 6 Indicative ISP project development stages

Stage	Future ISP projects identification	Preparatory activities for future projects	Project Assessment Draft Report (PADR)	Project Assessment Conclusions Report (PACR)	Contingent Project Application (CPA)
Description	<ul style="list-style-type: none"> Identification of future projects to include in the ISP High level assessment of potential costs/benefits to determine whether project has net benefits 	<ul style="list-style-type: none"> More detailed analysis of project options to determine provisional preferred option, and refine time, cost and technical scopes 	<ul style="list-style-type: none"> Comparison of credible options to determine the preferred option, taking into account submissions received on PSCR (if under previous ISP rules) 	<ul style="list-style-type: none"> Final report on the comparison of credible options to determine the preferred option, taking into account submissions received on PADR 	<ul style="list-style-type: none"> Final application to AER for revenue adjustment to reflect costs of the project
Cost estimates informed by	<ul style="list-style-type: none"> Specify approximate route High level line/substation specifications (e.g. voltage/capacity) 	<ul style="list-style-type: none"> Technical specifications refined, relevant network studies underway For significant projects a non-committal budget (guide) estimate from appropriate contractors/suppliers may be sought Desktop geotechnical/ecology/heritage/planning study undertaken, and some fieldwork may be undertaken in identified high risk areas 	<ul style="list-style-type: none"> Technical specifications refined, relevant network studies substantially complete For significant projects a non-committal budget (guide) estimate from appropriate contractors/suppliers may be sought Desktop geotechnical/ecology/heritage/planning study undertaken, and some fieldwork may be undertaken in 	<ul style="list-style-type: none"> Technical specifications completed For significant projects a non-committal budget (guide) estimate from appropriate contractors/suppliers may be sought Desktop geotechnical/ecology/heritage/planning study undertaken, and some fieldwork may be undertaken in identified high risk areas 	<ul style="list-style-type: none"> Detailed technical specifications completed for market costing Market engagement complete, procurement substantially progressed Detailed geotechnical investigations substantially progressed Procurement of options over easement commenced, initial consultation with landowners

Stage	Future ISP projects identification	Preparatory activities for future projects	Project Assessment Draft Report (PADR)	Project Assessment Conclusions Report (PACR)	Contingent Project Application (CPA)
		<ul style="list-style-type: none"> Stakeholder engagement plan developed Credible alignment path identified, avoiding significant known risks and environmental sensitivities Biodiversity offset liability estimated based on ecology reports available Corporate cost budget estimated at a high level 	<ul style="list-style-type: none"> identified high risk areas Major landowners identified Alignment developed based on Geotech/ecology/heritage/property ownership studies available Biodiversity offset liability estimated based on ecology reports available Corporate cost budget estimated at a high level 	<ul style="list-style-type: none"> Major landowners identified Alignment developed based on Geotech/ecology/heritage/property ownership studies available Biodiversity offset liability estimated based on ecology reports available Corporate cost budget estimated at a high level 	<ul style="list-style-type: none"> substantially complete Alignment finalised apart from micro-siting issues Biodiversity offset liability determined and strategy finalised Ecology/heritage studies substantially progressed Planning approval commenced Corporate cost budget finalised
Indicative Class	Class 5	Class 4 or 3	Class 4 or 3	Class 4 or 3	Class 3 or better
Cost source for ISP modelling	<i>Transmission Cost Database</i>	Primary cost estimate from TNSPs, cross check with <i>Transmission Cost Database</i>	Primary cost estimate from TNSPs, cross check with <i>Transmission Cost Database</i>	Primary cost estimate from TNSPs, cross check with <i>Transmission Cost Database</i>	Not required for committed projects

AEMO will produce cost estimates for future ISP projects using the *Transmission Cost Database*, which is designed to produce Class 5 estimates. As the projects move into Preparatory Activities or become actionable, the TNSPs produce Class 4, 3 or 2 estimates as they become further defined.

While the primary use of the *Transmission Cost Database* is to produce Class 5 estimates for future ISP projects, it will also be used to cross-check estimates received from TNSPs, to ensure consistency. This process is discussed further in Section 2.3.

AEMO includes all committed and anticipated projects in all future states of the world, in accordance with the AER's CBA Guidelines⁶. Because of this, the capital cost for committed and anticipated projects is not part of the ISP modelling process (similar to the capital cost of existing generation and transmission). Committed and anticipated projects are therefore not described in detail within this report.

2.2 Transmission Cost Database

The *Transmission Cost Database* was produced in response to stakeholder feedback on the 2020 ISP. Its objective is to provide increased transparency and accuracy of estimates of costs of future ISP projects, thereby enhancing the ISP outcomes and increasing stakeholder confidence in the estimates.

⁶ At <https://www.aer.gov.au/system/files/AER%20-%20Cost%20benefit%20analysis%20guidelines%20-%202025%20August%202020.pdf>.

AEMO engaged GHD as an expert independent consultant to create the *Transmission Cost Database*, and collaborated with NEM TNSPs and the AER during its design and construction. Stakeholder webinars were held in January and April 2021. Recordings and other material can be found on AEMO's website⁷.

The *Transmission Cost Database* is comprised of a Cost and Risk Data workbook containing all the fundamental components used to compile a project cost estimate, and a cost estimation tool with an interactive 'Dashboard' containing algorithms that processes the user inputs and selection choices.

As outlined in Figure 4, the *Transmission Cost Database* is intended for use by AEMO to generate Class 5 cost estimates for future ISP projects (or Class 4 in limited circumstances). It is not intended to produce more advanced estimates, as the breakdown of components is not sufficiently detailed. The *Transmission Cost Database* has been published to allow stakeholders to access the detail within the cost estimates, when assessing and providing feedback during the consultation.

2.2.1 Cost estimate components and treatment of risk

For the purposes of the *Transmission Cost Database*, cost estimates are broken down into several components, as outlined here:

- Building blocks and baseline cost.
- Adjustments for project specific attributes.
- Known risk allowance.
- Unknown risk allowance.
- Indirect costs.

These components are described in the following sections.

Building blocks

Cost estimates are typically initiated by defining the quantities of certain 'building blocks' or plant/equipment items and multiplying these by the unit cost per item (such as \$/km of overhead line or cost of a 500/330 kilovolt [kV] transformer). The list of building blocks required is developed by defining the scope of work required to deliver the project's objectives, and is the outcome of engineering design. The sum of the building block costs is the baseline cost.

Adjustments for project specific attributes

Building block costs will vary depending on many project-specific variables. It is therefore necessary to adjust the basic unit costs to take account of these factors. Building block adjustment factors are built into the *Transmission Cost Database* for selection by the user. They are based on past project data, and include the complexity of the project, its location, the type of terrain involved, and environmental factors. For large projects where a certain factor may change over the length of a transmission line, the project is broken into 'network elements' which can fit within a given selection. The selected adjustment factors are made transparent to stakeholders by listing them in each project table in Section 3 and Section 4 of this report. In addition, the numerical and percentage value of each adjustment factor is presented in the detailed output file for each project⁸.

Risk allowance

As estimates become more accurate, the quantities (scope) typically increase. Unit costs also tend to increase with design definition. The *Transmission Cost Database* accounts for these increases by defining two risk types:

⁷ AEMO. *Opportunities for engagement*, at <https://aemo.com.au/energy-systems/major-publications/integrated-system-plan-isp/2022-integrated-system-plan-isp/opportunities-for-engagement>.

⁸ See <https://www.aemo.com.au/consultations/current-and-closed-consultations/Transmission-costs-for-the-2022-Integrated-System-Plan>.

- Known risks – where risks are identified but the ultimate value of the risk is not known.
- Unknown risks – where the risk has not been identified but industry experience shows that in the course of major projects these can occur. With benefit of hindsight, such risks are not considered fully at the time of estimate preparation.

Indirect costs

Indirect costs represent the project owner’s internal costs. They represent all costs not covered by the contractors or suppliers.

2.2.2 Cost estimate progression

Figure 6 illustrates conceptually the summary cost structure used by the *Transmission Cost Database*. The relative heights of the bars in this figure are indicative and will vary according to the individual project details. The adjusted building block costs are shown as “known costs”. Known risk allowances and unknown risk allowances are added to the known costs to form the expected project cost. The known costs increasingly become a larger component of the total cost estimate, while risk allowances decrease as the design progresses. The expectation is that unknown risks will reduce to near zero as the project advances to delivery. The *Transmission Cost Database* has been designed to include an average unknown risk of 15% for all Class 5 estimates, such that the ‘total expected cost’ resulting from the *Transmission Cost Database* can be used as the mid-point of a symmetrical accuracy band for ISP modelling purposes.

The accuracy of the Class 5 estimates produced by the *Transmission Cost Database* is +/-30%.

Figure 6 Cost estimate summary breakdown from Class 5 to Class 1

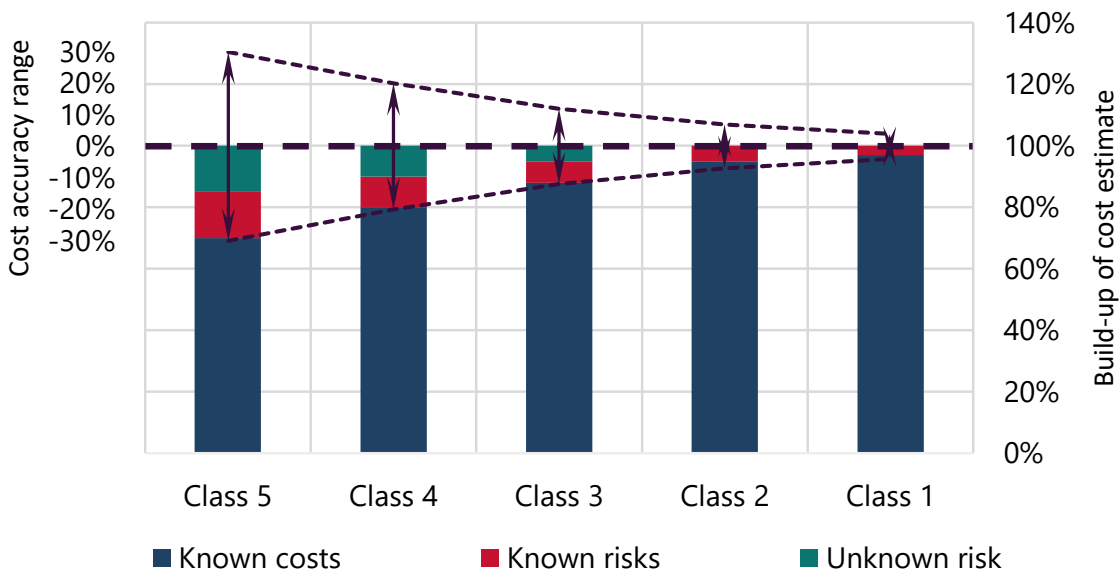

2.2.3 Transmission Cost Database detailed structure and content

The *Transmission Cost Database* consists of two separate Excel files:

- A Cost and Risk Data workbook containing all the fundamental components used to compile a project cost estimate.
- A cost estimation tool with interactive ‘Dashboard’ containing algorithms that processes the user inputs and selection choices.

The algorithms within the *Transmission Cost Database* are written using VBA programming language within macros. The *Transmission Cost Database* cost estimation tool is available for stakeholder use and contains a

complete copy of the Cost and Risk Data. A detailed user manual is also provided – these files along with instructions on how to download and run the tool are available on the AEMO website⁹.

Full details of the *Transmission Cost Database* construction including cost and risk data sources are given in GHD’s report¹⁰.

An illustration of the detailed cost breakdown structure used in the cost estimation tool is provided in Figure 7. This shows how each main component of the estimate (such as ‘building blocks’ or ‘known risks’, as described in Section 2.2.1) is broken down into sub-components for user input, which are then combined to build up the full estimate.

Figure 7 Cost breakdown structure

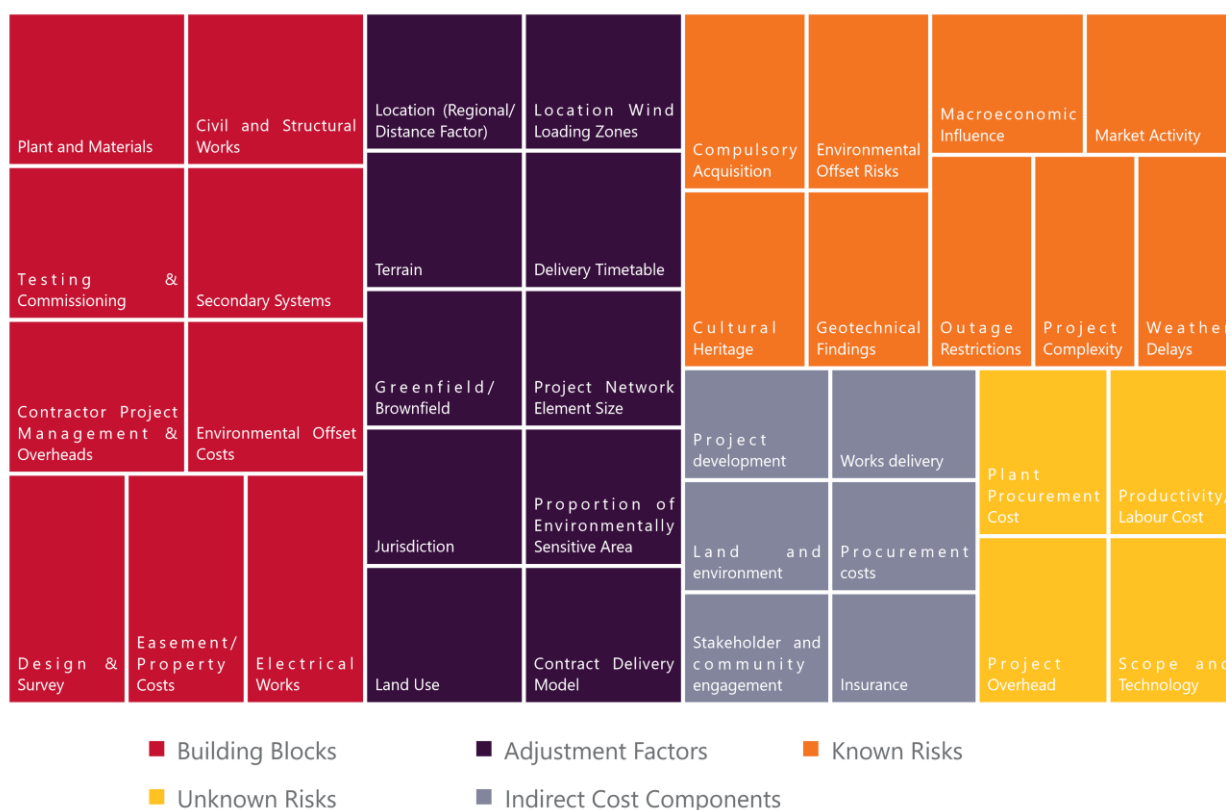

To select a building block in the estimating tool, the user chooses from lists of plant items, which are broken into categories (for example, overhead line, station), and sub-categories (such as 330 kV overhead line, 500/330 kV transformer). The user then selects the appropriate adjustment factors and risks for each item. A complete listing of the categories and sub-categories that make up the estimates is provided in GHD’s report, and detailed notes with guidance for selection of adjustment and risk factors are included within the *Transmission Cost Database* itself.

Large projects are broken down into several network elements, such as a segment of a major transmission line, or a major substation component, and adjustments and risk factors are applied to the building block costs for each network element. These costs are then summed, along with indirect costs for the overall project, to produce the expected project cost.

The calculation sequence used in the *Transmission Cost Database* is described below.

⁹ AEMO. *Transmission Costs for the 2022 Integrated System Plan*, available at <https://www.aemo.com.au/consultations/current-and-closed-consultations/Transmission-costs-for-the-2022-Integrated-System-Plan>.

¹⁰ At <https://www.aemo.com.au/consultations/current-and-closed-consultations/Transmission-costs-for-the-2022-Integrated-System-Plan>.

Table 7 Transmission Cost Database calculation sequence

Reference	Cost estimate component
n	Number of network elements in a project [Project = network element ₁ + network element ₂ + + network element _n]
A	Baseline cost estimate for a given network element
B	Adjusted baseline cost estimate for a given network element
C	Known risk allowance for a given network element
D	Unknown risk allowance for a given network element
E	(B + C + D) for a given network element
$\sum E_{1 \text{ to } n}$	$E_1 + E_2 + \dots + E_n$
F	Indirect costs for the overall project
G	$\sum E_{1 \text{ to } n} + F = \text{Expected project cost}$

2.2.4 Calibration

Due to the lack of recent large-scale transmission line projects constructed in Australia, a selection of network elements from large-scale transmission and substation projects in the advanced stages of design was used as a set of benchmarks against which to calibrate the cost and risk data in the *Transmission Cost Database*.

Following calibration, the majority (14 of the total 16 network elements) of the *Transmission Cost Database* outputs were within $\pm 15\%$ of the benchmark reference cost estimates. This positioning provides confidence that the cost estimates generated by the *Transmission Cost Database* are in alignment with the latest industry reference.

2.2.5 Limitations

The user needs to input and choose their selections in the *Transmission Cost Database* based on the assumed scope and definition of the project. Knowledge of power system design is required to accurately specify the inputs to the tool. Users should also note the following:

- The output is a Class 5 estimate and therefore suitable only for the purposes of the ISP, for early stage of project development.
- The output is a point estimate calculated in a deterministic or parametric fashion. In other words, it is not a 'P-' estimate and does not have any associated statistical qualification (for example, confidence level, probability distribution functions, standard deviation). No stochastic simulation was involved in the *Transmission Cost Database* cost estimation.
- The building block costs are in real 2021 Australian dollar values, therefore, the output is in 2021 Australian dollars. AEMO may adjust the output using CPI to ensure consistency with other costs in the ISP.
- The output represents Australian construction environment, asset and design standards, industry and business practices, regulatory framework, commercial rules, labour laws, and safety regulations in 2021.
- The output represents stable macroeconomic (forex, commodity, labour and wage price indices), social and political conditions that Australia has experienced in recent years up to 2021.
- The output represents efficient preliminary investigation, project development, project management, competitive tendering, site management and contractual arrangements.

2.3 Review of TNSP cost estimates

The purpose of this section is to outline AEMO's approach to reviewing cost estimates provided by TNSPs such that they are complete and consistent.

While AEMO has adopted the AACE standard for the ISP, this standard is not currently a requirement for TNSPs. TNSPs each have a unique project cost estimation process that has evolved through the development of their respective transmission project portfolios.

A number of typical project characteristics influence these processes, including:

- The technical scope of projects.
 - Inclusion of transmission lines, station works or cabling.
 - Degree of risk definition throughout the maturity of each project.
- The degree of information available at the earliest stage of each project.
- Recent experience in procuring sites, land, and easement corridors.

2.3.1 Objectives

AEMO is engaging with each TNSP to establish a process to ensure cost estimates are aligned across all projects in AEMO's ISP modelling. The objectives of this engagement are as follows:

- Improve transparency of how TNSPs develop estimates for projects, including the different stages of cost estimation, inclusion of risk allowances, and accuracy that is achieved at each stage.
- Develop a common definition of work required to meet each estimate class for transmission projects.
- Develop a process to align TNSP estimates and enable a consistent approach for inclusion of risk.

2.3.2 Checklist development

AEMO engaged with the AER and TNSPs to develop a checklist which reflects various aspects of a project at different stages of maturity.

For example, one indicator of the amount of design that has been completed on a project is the level of documentation that has been prepared. This aspect forms one line on the checklist; 'Level of Documentation' can be described as:

- Class 5: Conceptual single line diagram.
- Class 4: Detailed single line diagram.
- Class 3/2/1: 'For Construction' electrical and civil diagrams.

The engagement process focused on discussions with TNSPs about cost estimation processes, project stages, and stage definitions. The resulting checklist is shown in Appendix A1, and will be used to approximate the class of each estimate that is provided by TNSPs.

2.3.3 Review and adjustment process

AEMO expects to receive completed TNSP checklist responses by 2 June 2021, and TNSP cost estimates for actionable projects and projects with preparatory activities by 30 June 2021. These estimates will be subject to review and adjustment in accordance with this cost classification process.

The proposed process to review the TNSP estimates consists of three stages, as outlined here:

1. Classification and preliminary screening of cost estimates:
 - a) TNSP provides completed checklist responses for each project option (ahead of providing cost estimate).

- b) AEMO approximates the class of the estimate for that project option. This will be done by reviewing the set of TNSP responses against the AEMO checklist. The assigned class will be that which has the highest correlation against the responses.
 - c) AEMO reviews the TNSP's allocation for unknown risks against the expectation for the assigned class (See Section 2.2.2).
 - d) AEMO works with the TNSP to resolve any missing cost components or differences in risk allocation treatments.
2. Review of cost estimates:
- a) TNSP provides cost estimate for each project option.
 - b) AEMO estimates cost in parallel, using the *Transmission Cost Database*.
 - c) AEMO compares estimates, and works with the TNSP to resolve any significant differences in cost components or risk allowances.
 - d) TNSP reviews and updates cost estimate as they deem appropriate, and provides updated estimate to AEMO.
3. Final alignment of cost estimates:
- a) AEMO carries out final review of TNSP updated estimate.
 - b) Where sufficient information has not been provided to AEMO, or where missing or insufficient allowance has been made for cost components or risk, AEMO may decide to add an additional allowance based on the *Transmission Cost Database*.
 - c) Where this is done, AEMO will notify the TNSP, and provide information on the adjustments, and reasons for same, in the final *Transmission Cost Report*.

The following hypothetical example illustrates how AEMO intends to apply the adjustment process:

Table 8 Example estimate adjustment

Cost component	\$ million
TNSP initial cost estimate	\$1,000
Apply known risk allowance for weather delays	\$40
TNSP updated cost estimate	\$1,040
AEMO applies class 4 unknown risk allowance	\$94
ISP cost input	\$1,134

The review steps for this hypothetical example are as follows:

1. Prior to completion of its cost estimate, the TNSP provides a set of checklist responses for the project option to AEMO and the TNSP designates this estimate as Class 4.
 - AEMO reviews using the checklist and finds that this estimate will be consistent with Class 4, however notes that no allowance is planned for environmental offsets.
 - AEMO advises the TNSP of missing environmental offset allowance, and of agreement with Class 4 assignment.
2. TNSP completes initial cost estimate and provides it to AEMO, including the cost breakdown.
 - The cost estimate total is \$1,000 million, including an allowance which the TNSP has made for environmental offsets.

- AEMO compares with the *Transmission Cost Database* result and finds no allowance has been made for weather delay risk or unknown risks. The site is located in an area with unfavourable weather conditions over much of the year.
 - AEMO notifies the TNSP and recommends addition of these allowances.
 - TNSP responds with additional \$40 million for weather delay risk (based on its own assessment) but no inclusion of allowance for unknown risk.
3. AEMO reviews the updated cost estimate.
- An allowance of \$94 million is added by AEMO for unknown risks (based on an assumed 9% for Class 4 unknown risk as per the *Transmission Cost Database*).
 - This cost estimate is now aligned to Class 4, and is ready for input to ISP modelling.

It should be noted that AEMO intends to apply adjustments only where it is clear that they are required. Feedback from TNSPs will be sought to ensure correct alignment of cost estimates. Any adjustments made, along with the reasoning for them, will be documented clearly in the final *Transmission Cost Report*.

2.4 Estimating operational expenditure

To estimate the operational expenditure for transmission projects, 1% of the total capital cost per annum is assumed as operation and maintenance cost for each transmission project.

If more detailed information is provided from a TNSP, and AEMO is satisfied with the evidence provided, this may take precedence over the 1% assumption.

3. Flow paths

Flow paths are a feature of power system networks, representing the main transmission pathways over which bulk energy is shipped. They are the portion of the transmission network used to transport significant amounts of electricity across the backbone of the network to load centres. Flow paths change as new interconnection is developed, or as a result of shifting large amounts of generation into new areas (such as in the case of major REZ development). Some upgrades to flow paths are already committed or anticipated (see Table 3). This chapter presents credible augmentation options to increase the transfer capability of flow paths in the ISP.

The following information is presented for each augmentation option:

- A description of the option.
- The expected increase in transfer capacity.
- The project cost, including the class of the estimate and associated accuracy.
- An overview of characteristics which are key cost drivers.

Many of augmentation options included in this section are either undergoing the RIT-T (see Table 4) or have Preparatory Activities being developed (see Table 5). Transfer limits and cost estimates of these augmentation options will be sourced from respective TNSPs and included in the final *Transmission Cost Report*.

3.1 Overview

The augmentation options to increase the transfer capability of flow paths presented in this section are aligned with the network topology proposed for 2022 ISP in the Draft 2021 IASR¹¹. Augmentation options between the sub-regions were also presented in the Draft 2021 IASR.

These augmentation options can be categorised as follows:

- **Central and North Queensland (CNQ) to Gladstone Grid (GG)** – also referred to as “Gladstone Grid Reinforcement”, this is an option to increase transfer capacity between the CNQ and GG sub-regions for which AEMO triggered preparatory activities – see Section 3.3.
- **Southern Queensland (SQ) – CNQ** – options to increase transfer capacity between the SQ and CNQ sub-regions, including the Central to Southern Queensland Transmission Link for which AEMO triggered preparatory activities – see Section 3.4.
- **Northern New South Wales (NNSW) – SQ** – options to increase the transfer capability between NNSW and SQ. This includes components of the QNI Medium and Large projects for which AEMO triggered preparatory activities – see Section 3.5.
- **Central New South Wales (CNSW) – NNSW** – options to increase the transfer capability between CNSW and NNSW. This includes components of the QNI Medium and Large projects and components of New England and North West New South Wales REZ upgrades for which AEMO triggered preparatory activities – see Section 3.6.

¹¹ AEMO, 2021 *Inputs and Assumptions Workbook*. Section 4.11 Network Modelling, at https://www.aemo.com.au/-/media/files/electricity/nem/planning_and_forecasting/inputs-assumptions-methodologies/2021/draft-2021-inputs-assumptions-and-scenarios-report.pdf?la=en.

- **CNSW – Sydney, Newcastle and Wollongong (SNW)** – options to reinforce supply to Sydney, Newcastle and Wollongong load centres following retirement of coal power generators in New South Wales. This includes the Reinforcing Sydney, Newcastle and Wollongong Supply project for which AEMO triggered preparatory activities – see Section 3.7.
- **Southern New South Wales (SNSW) – CNSW** – options to increase the transfer capability between SNSW and CNSW, currently proposed to be increased via the HumeLink¹² project – see Section 3.8.
- **Victoria – SNSW** – options to increase the transfer capability between Victoria and SNSW. This includes augmentation options considered as part of the Victoria – New South Wales Interconnector (VNI) West¹³ project – see Section 3.9.
- **Tasmania – Victoria** – this includes Project Marinus Link¹⁴, a proposed new interconnector to increase the transfer capability between Tasmania and Victoria – see Section 3.10.
- **New South Wales – South Australia** – this includes Project EnergyConnect, the proposed new interconnector between Southern New South Wales and South Australia. ElectraNet and TransGrid have completed the RIT-T and are currently awaiting the AER’s decision on a revised contingent project application¹⁵ – see Section 3.11.

The different corridors associated with these options are illustrated in Figure 8 and described in more detail in the following sections.

¹² TransGrid. *HumeLink*, at <https://www.transgrid.com.au/humelink>.

¹³ AEMO. *VNI West*, at <https://aemo.com.au/en/initiatives/major-programs/victoria-to-new-south-wales-interconnector-west-regulatory-investment-test-for-transmission>.

¹⁴ TasNetworks. *Marinus Link*, at <https://www.marinuslink.com.au/>.

¹⁵ AER. TransGrid and ElectraNet – Project EnergyConnect contingent project, at <https://www.aer.gov.au/networks-pipelines/determinations-access-arrangements/contingent-projects/transgrid-and-electranet-%E2%80%93-project-energyconnect-contingent-project>.

Figure 8 Flow path development options

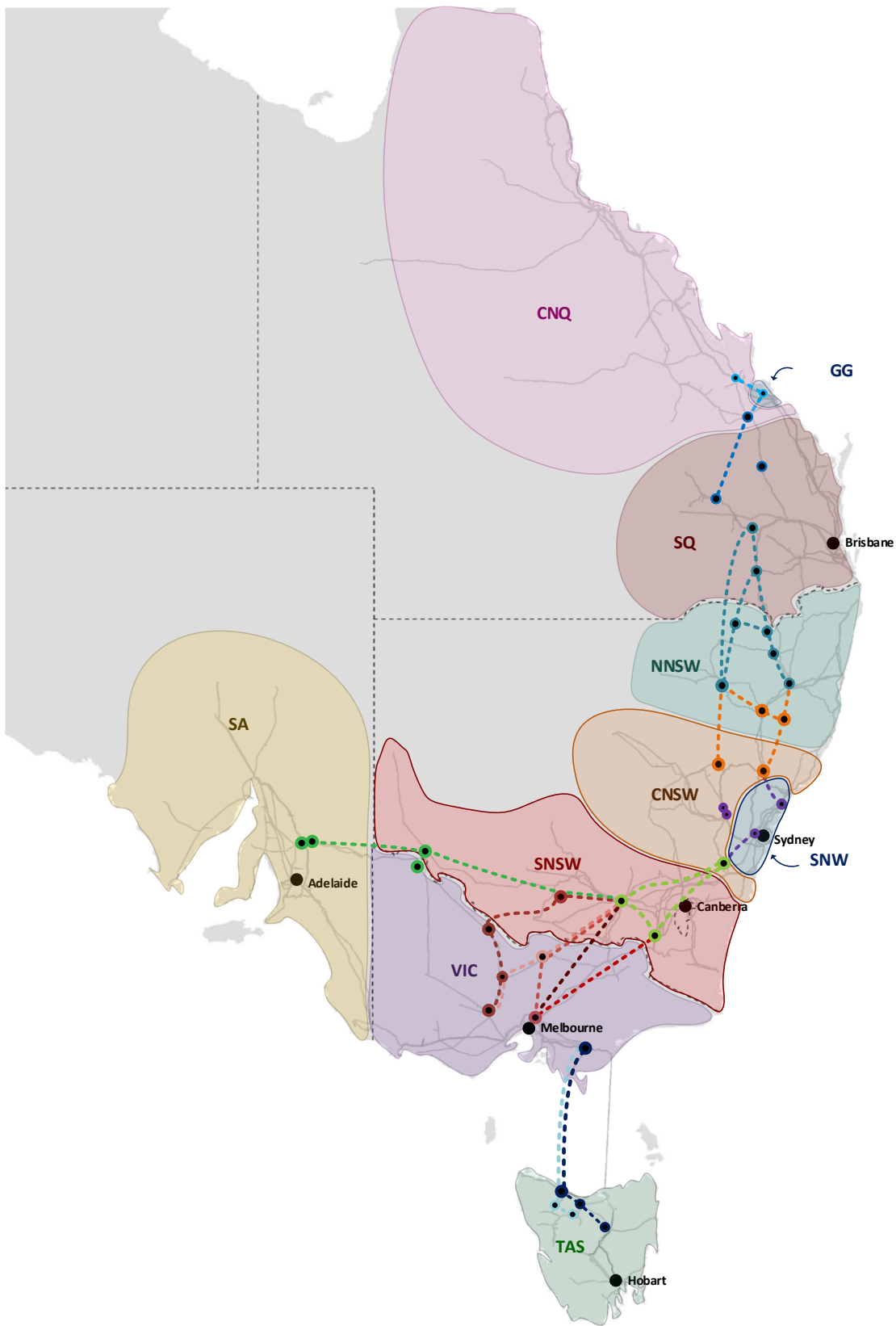

3.2 Legend and explanation of tables

The tables in the following sections (and in chapter 4) provide an overview of the characteristics of each network development option. The following template explains the criteria and terminology used in the tables.

Summary	
A brief description of the existing network is provided (for example, network capacity, projects to increase capacity, findings from the 2020 ISP).	
Existing network capability	
<p>For flow paths, this is the approximate maximum forward and reverse flow capability between the regions or sub-regions. These capabilities are represented by nominal transfer capacity when there are no transmission network outages in the local area. The capacity is sourced from recent historical data.</p> <p>For REZs, this is the capacity of the specific area of the network to allow connection of variable renewable energy (VRE) prior to curtailment being anticipated.</p> <p>The limit is the notional maximum transfer limit at the time of "Summer 10% probability of exceedance (POE) demand" (referred to as 'peak demand'), "Summer Typical", and "Winter Reference" in the importing region as referred to in the <i>Draft ISP Methodology</i>. The figure quoted is the minimum of the following required limits: transmission asset thermal capacity; voltage stability; transient stability; oscillatory stability; and system strength and inertia.</p>	
Augmentation options – these include the capability, cost and timing for flow path augmentation options	
Additional network capacity (MW)	This is the additional network transfer capacity for each of the identified options and based on power system studies undertaken by AEMO or TNSPs. For flow paths the direction of power flow is stated. For REZs, the power flow is always in one direction from the REZ to the network.
Cost	<p>The costs are based on 2021 figures in (\$ million). All cost estimates, except for projects currently progressing in RIT-T and identified as Preparatory Projects in the 2020 ISP, are indicative and sourced from AEMO's <i>Transmission Cost Database</i>. Cost estimates for projects which are currently progressing in RIT-T or Preparatory Activities will be sourced from respective TNSPs.</p> <p>Costs shown in this report are rounded to two significant figures for readability. Exact costs from the Transmission Cost Database or from the TNSPs will be used in the ISP modelling, and will be documented in the IASR Workbook.</p>
Cost classification	This is based on either AEMO's <i>Transmission Cost Database</i> or TNSP's cost estimates information based on the AACE Cost Estimate Classification System as referenced in Section 2.3.
Lead time	Represent the likely minimum time for service from the date of publication of the final 2022 ISP. The lead time includes regulatory justification and approval, relevant community engagement and planning approvals, procurement, construction, commissioning, and inter-network testing. This lead time is categorised as short (1-3 years), medium (3-5 years), or long (beyond five years).
Adjustment factors and risk – notes the adjustment factors, known risks and unknown risks applied to the option, for those estimates which were developed with the <i>Transmission Cost Database</i>.	
<p>Adjustment factors:</p> <ul style="list-style-type: none"> • Location (urban, regional and remote). • Greenfield/brownfield (greenfield, brownfield and partly brownfield) – greenfield is chosen unless otherwise specified. • Land use (desert, scrub, grazing and developed area). • Terrain (flat/farmland, mountainous and hilly/undulating). • Legislative jurisdiction (NSW, QLD, SA, TAS and VIC). • Scale modifiers (transmission line length, project size). • Delivery timeframe (optimum, tight, long). • Contract delivery model (EPC contract, D&C contract) – EPC contract is chosen unless otherwise specified. • Proportion of environmentally sensitive areas (None, 25%, 50%, 75% and 100%). • Location wind loading zones (cyclone and non-cyclone regions) – non-cyclone region is chosen unless otherwise specified. 	

Known risk: where the risks are identified but ultimate value is not known. There are nine known risk factors:

- Compulsory acquisition (BAU, low and high).
- Cultural heritage (BAU, low and high).
- Environmental offset risks (BAU, low and high).
- Geotechnical findings (BAU, low and high).
- Macroeconomic influence (BAU, increased uncertainty and heightened uncertainty).
- Market activity (BAU, tight and excess capacity).
- Outage restrictions (BAU, low and high).
- Project complexity (BAU, partly complex and highly complex).
- Weather delays (BAU, low and high).

Unknown risk: where the risk has not been identified but industry experience indicates these could occur:

- Scope and technology.
- Productivity and labour cost.
- Plant procurement cost.
- Project overhead.

3.3 Central and North Queensland to Gladstone Grid

Summary				
<p>With retirement or reduced generation from Gladstone Power Station and increased generation in North Queensland, the Boyne Island, Calliope River, Larcom Creek and Raglan substations cannot be supplied.</p> <p>In the 2020 ISP, AEMO recommended Powerlink complete preparatory activities for reinforcement of Central and North Queensland (CNQ) and Gladstone Grid (GG) section. One network option is proposed to increase the maximum network transfer capability between CNQ and GG. Powerlink will provide the cost and capability of this option by 30 June 2021.</p>		 <p>Option 1</p>		
Existing network capability				
<p>The maximum power transfer from CNQ to Gladstone grid section is limited by thermal capacity of the Calvale–Wurdong, Bouldercombe–Raglan, Larcom Creek–Calliope River or Calliope River–Wurdong 275 kV circuits.</p> <p>At peak demand levels CNQ to GG transfer capability is approximately 615 MW.</p> <p>An update to transfer capacity is to be provided by Powerlink as part of preparatory activities.</p>				
Augmentation options				
Description	Additional network capacity (MW)	Expected cost (\$ million)	Cost classification	Lead time
<p>Option 1:</p> <ul style="list-style-type: none"> • New 275 kV double-circuit line between Calvale and Calliope River. • Rebuild the Bouldercombe–Raglan–Larcom Creek–Calliope River and the Bouldercombe–Calliope River 275 kV single-circuit lines as a high capacity double-circuit line. • Turn both circuits into Larcom Creek. • Turn a single circuit into Raglan. • Third Calliope River 275/132 kV transformer. 	<p><i>To be provided by Powerlink by 30 June 2021.</i></p>			
Adjustment factors and risk				
	Adjustment factors applied	Known and unknown risks applied		
Option 1	Pending information from Powerlink by 30 June 2021.			

3.4 Southern Queensland to Central & North Queensland

Summary				
<p>The maximum transfer capability from Central and Northern Queensland (CNQ) to Southern Queensland (SQ) is currently limited to approximately 2,100 MW. As new generation connects in CNQ, congestion along this corridor will increase and generation will be curtailed.</p> <p>In the 2020 ISP, AEMO recommended Powerlink complete preparatory activities to increase transfer capability from CNQ to SQ. Four options are proposed to increase the maximum network transfer capability between CNQ and SQ. Powerlink will provide the cost and capability of option 1 by 30 June 2021.</p>				
Existing network capability				
<p>CNQ to SQ maximum transfer capability is approximately 2,100 MW. This capability is applicable in peak demand, summer typical, and winter reference periods. The maximum power transfer from CNQ to SQ grid section is limited by transient or voltage stability following a Calvale to Halys 275 kV circuit contingency.</p>				
Augmentation options				
Description	Additional network capacity (MW)	Expected cost (\$ million)	Cost classification	Lead time
<p>Option 1:</p> <ul style="list-style-type: none"> A new 275 kV double-circuit line between Calvale and South West of Queensland. 	<i>To be provided by Powerlink by 30 June 2021.</i>			
<p>Option 2:</p> <ul style="list-style-type: none"> Mid-point switching substation on the Calvale – Halys 275 kV double-circuit line. 	North: 300 MW South: 300 MW REZ NQ3: 300 MW	60	Class 5 (±30%)	Short
<p>Option 3:</p> <ul style="list-style-type: none"> Non-network option – a Virtual Transmission Line option with a 300 MW energy storage system in north of Calvale and South of Halys. 	North: 300 MW South: 300 MW REZ NQ3: 300 MW	To be provided by interested parties	N/A	To be provided by interested parties
<p>Option 4:</p> <ul style="list-style-type: none"> HVDC 2,000 MW bi-pole between Calvale and South West Queensland. 	North: 1,750 MW South: 1,750 MW REZ NQ3: 1,750 MW	1,630	Class 5 (±30%)	Long
Adjustment factors and risk				
Option	Adjustment factors applied		Known and unknown risks applied	
Option 1	Pending information from Powerlink by 30 June 2021.			
Option 2	<ul style="list-style-type: none"> Location: Regional Proportion of environmentally sensitive areas: 50% 	<ul style="list-style-type: none"> Land use: Scrub Delivery timetable: Optimum Project size: 1-5 bays 	<ul style="list-style-type: none"> Known risks: BAU Unknown risks: Class 5 	<ul style="list-style-type: none"> Outage restrictions: High
Option 3	Pending information from interested parties.			
Option 4	<ul style="list-style-type: none"> Location: Remote Land use: Grazing Project size: applicable for HVDC converter station Terrain: Flat/Farmland 	<ul style="list-style-type: none"> Delivery timetable: Long Total circuit length: above 200 km Proportion of environmentally sensitive areas: 50% 	<ul style="list-style-type: none"> Known risks: BAU Unknown risks: Class 5 	<ul style="list-style-type: none"> Project complexity: Highly complex

3.5 Northern New South Wales – Southern Queensland

Summary				
<p>The Northern New South Wales (NNSW) and Southern Queensland (SQ) corridor represents a portion of the network which forms part of the Queensland – New South Wales Interconnector (QNI). Development options on this corridor include the northern sections of proposed QNI upgrades.</p> <p>A project to increase the transfer capacity of the existing QNI (referred as 'QNI Minor') has been committed†.</p> <p>In addition to QNI Minor, in the 2020 ISP, AEMO recommended Powerlink and TransGrid complete preparatory activities for QNI Medium and Large interconnector upgrades. Four options are proposed to increase the maximum network transfer capability between NNSW and SQ.</p>				
Existing network capability				
<p>Transfer capability with future options will be modelled with QNI minor upgrade in service.</p> <p>Indicative transfer limits from 2021 Draft IASR: NNSW to SQ is 835 MW and SQ to NNSW is 1,310 MW at times of peak demand period.</p> <p>Transfer capabilities are to be updated by TransGrid and Powerlink as part of preparatory activities by 30 June 2021.</p>				
Augmentation options				
Description	Additional network capacity (MW)	Expected cost (\$ million)	Cost classification	Lead time
<p>Option 1:</p> <ul style="list-style-type: none"> A new 330 kV double-circuit line (one circuit strung) from south of Armidale to Dumaresq to Bulli Creek to Braemar. 				<i>To be provided by Powerlink and TransGrid by 30 June 2021.</i>
<p>Option 2:</p> <ul style="list-style-type: none"> An additional new 330 kV circuit (second circuit strung) from south of Armidale to Dumaresq to Bulli Creek to Braemar. <p><i>Pre-requisite: NNSW-SQ Option 1.</i></p>				<i>To be provided by Powerlink and TransGrid by 30 June 2021.</i>
<p>Option 3:</p> <ul style="list-style-type: none"> A Virtual Transmission Line option with a 300 MW energy storage system south of Armidale and north of Braemar. 	300 MW in both directions. REZ N1:300 MW	To be provided by interested parties	Not applicable	Short
<p>Option 4:</p> <ul style="list-style-type: none"> A new HVDC 2,000 MW bi-pole interconnector between a new substation in North West New South Wales (NWNSW) REZ and Western Downs. A new 330 kV line between NWNSW REZ and Tamworth 	1,750 MW in both directions REZ N1: 1,750 MW	2,760	Class 5 (±30%)	Long
Adjustment factors and risk				
Option	Adjustment factors applied	Known and unknown risks applied		

Options 1 and 2	Pending information from Powerlink and TransGrid by 30 June 2021.		
Option 3	Pending information from interested parties		
Option 4	<ul style="list-style-type: none"> • Location: Remote • Land use: Grazing • Project size: applicable for HVDC converter station • Terrain: Hilly/undulating 	<ul style="list-style-type: none"> • Delivery timetable: Long • Total circuit length: above 200 km • Proportion of environmentally sensitive areas: 50% 	<ul style="list-style-type: none"> • Known risks: BAU • Unknown risks: Class 5 • Project complexity: Highly complex

† AEMO, Draft IASR, at <https://www.aemo.com.au/consultations/current-and-closed-consultations/2021-planning-and-forecasting-consultation-on-inputs-assumptions-and-scenarios>.

3.6 Central New South Wales to Northern New South Wales

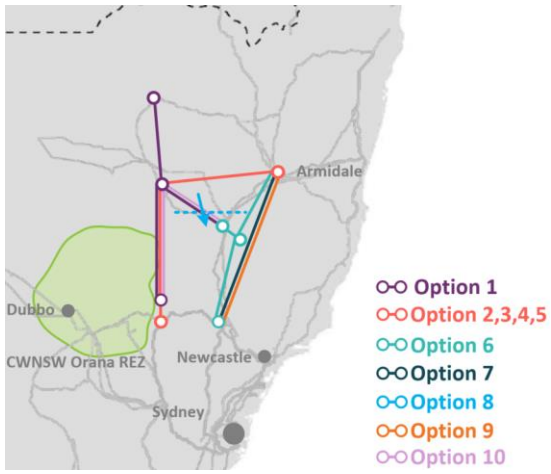
Summary				
<p>The Central New South Wales (CNSW) to Northern New South Wales (NNSW) corridor represents a portion of the network which forms part of QNI. Development options on this corridor include the southern sections of proposed QNI upgrades.</p> <p>A project to increase the transfer capacity of the existing QNI (referred to as 'QNI Minor') has been committed[†].</p> <p>In addition to QNI Minor, in the 2020 ISP, AEMO recommended that Powerlink and TransGrid complete preparatory activities for QNI Medium and Large interconnector upgrades and TransGrid complete preparatory activities for New England REZ and North West REZ. Alternative options are being proposed by TransGrid.</p> <p>Including alternative options, 10 options are proposed to increase the maximum network transfer capability between CNSW and NNSW.</p>		 <p>Note: The Central West Orana REZ is shown in green – see Section 4.2.3 for more information.</p>		
Existing network capability				
<p>Transfer capability of future options will be modelled with QNI minor upgrade in service.</p> <p>Transfer capabilities are to be provided by TransGrid and Powerlink as part of preparatory activities by 30 June 2021.</p>				
Augmentation options				
Description	Additional network capacity (MW)	Expected cost (\$ million)	Cost classification	Lead time
<p>Option 1:</p> <ul style="list-style-type: none"> Two new 500 kV circuits from Orana REZ to near Boggabri to Moree. A 330 kV single-circuit line from near Boggabri to Tamworth. 		<i>To be provided by TransGrid by 30 June 2021.</i>		
<p>Option 2:</p> <ul style="list-style-type: none"> A new 500 kV single-circuit line from south of Armidale to near Boggabri to Orana REZ. A single 500 kV circuit from Orana REZ to Wollar. 		<i>To be provided by TransGrid by 30 June 2021.</i>		
<p>Option 3:</p> <ul style="list-style-type: none"> An additional new 500 kV single circuit from south of Armidale to near Boggabri to Orana REZ. <p><i>Pre-requisite: CNSW-NNSW Option 2.</i></p>		<i>To be provided by TransGrid by 30 June 2021.</i>		
<p>Option 4:</p> <ul style="list-style-type: none"> A new 500 kV double-circuit line (one circuit strung) from south of Armidale to near Boggabri to Orana REZ, and A single 500 kV circuit from Orana REZ to Wollar. 		<i>To be provided by TransGrid by 30 June 2021.</i>		

Option 5: <ul style="list-style-type: none"> An additional new 500 kV circuit (second circuit strung) from south of Armidale to near Boggabri to Orana REZ. <i>Pre-requisite: CNSW-NNSW Option 4</i>	<i>To be provided by TransGrid by 30 June 2021.</i>			
Option 6: <ul style="list-style-type: none"> Two new 500 kV lines from south of Armidale to Bayswater via a new substation east of Tamworth, and A 330 kV single-circuit from a new substation east of Tamworth to Tamworth. 	<i>To be provided by TransGrid by 30 June 2021.</i>			
Option 7: <ul style="list-style-type: none"> A new 330 kV double-circuit line from south of Armidale to Liddell. 	1,145 MW from CNSW to NNSW. 1,115 MW from NNSW to CNSW.	820	Class 5 (±30%)	Long
Option 8: <ul style="list-style-type: none"> Non-network option - A Virtual Transmission Line option with a 300 MW energy storage system south of Liddell and north of Armidale. 	300 MW in both directions REZ N2: 300 MW	To be provided by interested parties	Not applicable	Short
Option 9: <ul style="list-style-type: none"> 2,000 MW bi-pole HVDC transmission system between Bayswater and south of Armidale. 	1,750 MW in both directions REZ N2: 1,750 MW	1,790	Class 5 (±30%)	Long
Option 10: <ul style="list-style-type: none"> A 2,000 MW bi-pole HVDC transmission system between a new substation in Orana and near Boggabri. A new 330 kV ac line between near Boggabri and Tamworth. 	1,750 MW in both directions REZ N2: 1,750 MW	1,860	Class 5 (±30%)	Long

Adjustment factors and risk

Option	Adjustment factors applied	Known and unknown risks applied
Options 1 to 6	Pending information from TransGrid by 30 June 2021.	
Option 7	<ul style="list-style-type: none"> Location: Remote Land use: Grazing Project size: Project size: 1-5 bays Terrain: Hilly/undulating Delivery timetable: Long Total circuit length: above 200 km Proportion of environmentally sensitive areas: 50% 	<ul style="list-style-type: none"> Known risks: BAU Unknown risks: Class 5
Option 8	Pending information from interested parties	
Options 9 and 10	<ul style="list-style-type: none"> Location: Remote Land use: Grazing Project size: applicable for HVDC converter station Terrain: Hilly/undulating Delivery timetable: Long Total circuit length: above 200 km Proportion of environmentally sensitive areas: 50% 	<ul style="list-style-type: none"> Known risks: BAU Unknown risks: Class 5 Project complexity: Highly complex

† AEMO, Draft IASR, at <https://www.aemo.com.au/consultations/current-and-closed-consultations/2021-planning-and-forecasting-consultation-on-inputs-assumptions-and-scenarios>.

3.7 Central New South Wales to Sydney, Newcastle and Wollongong

Summary				
<p>The transmission network in the Sydney, Newcastle and Wollongong (SNW) area was originally designed to connect large coal-fired generators in the Hunter Valley to supply the SNW load centres. When these coal-fired generators retire, the network has insufficient capability to supply SNW load centres from generators located outside of the Hunter Valley. Additional transmission network augmentation may be needed to supply the load centre.</p> <p>In the 2020 ISP, AEMO recommended TransGrid complete preparatory activities for reinforcement of SNW supply. Two options are proposed to increase the maximum network transfer capability from Central New South Wales (CNSW) to SNW.</p>				
Existing network capability				
<p>Existing transfer capability varies depending on load and generation distribution within Sydney, Newcastle and Wollongong areas. At times of peak demand, transfer capacity is estimated to be 5,600 MW from CNSW to SNW.</p> <p>Transfer capabilities are to be provided by TransGrid and as part of preparatory activities by 30 June 2021.</p>				
Augmentation options				
Description	Additional network capacity (MW)	Expected cost (\$ million)	Cost classification	Lead time
<p>Option 1:</p> <ul style="list-style-type: none"> New 500 kV double-circuit line between Bayswater and Eraring. 				<i>To be provided by TransGrid by 30 June 2021.</i>
<p>Option 2:</p> <ul style="list-style-type: none"> New 500 kV double-circuit line between Bannaby and near South Creek. Rebuild near South Creek–Sydney West 330 kV single-circuit line as double-circuit 330 kV line. Two 500/330 kV, 1,500 MVA transformers at near South Creek. 				<i>To be provided by TransGrid by 30 June 2021.</i>
Adjustment factors and risk				
Option	Adjustment factors applied	Known and unknown risks applied		
Options 1 and 2	Pending information from TransGrid by 30 June 2021.			

3.8 Southern New South Wales to Central New South Wales

Summary				
<p>The transmission network between Southern New South Wales (SNSW) and Central New South Wales (CNSW) provides access for the hydroelectric generation in the Snowy mountains, renewable generation in SNSW and South-West NSW (SWNSW), and import from Victoria and South Australia to NSW major load centres.</p> <p>HumeLink is a proposed transmission network augmentation that reinforces the New South Wales southern shared network to increase transfer capacity to NSW load centres. This is an actionable 2020 ISP project. TransGrid is currently undertaking a RIT-T for this network augmentation. The Project Assessment Draft Report (PADR), the second report of the RIT-T, was published in January 2020.</p> <p>Subsequent to HumeLink, two options are proposed to increase the maximum network transfer capability between SNSW and CNSW to access increased import from Victoria and South Australia with increased generation in SNSW to NSW major load centres.</p>				
Existing network capability				
<p>At times of peak demand, transfer capacity is estimated to be 2,700 MW from SNSW to CNSW. This transfer capability is limited by thermal capacity of a Yass-Marulan 330 kV circuit for a contingent outage of the parallel circuit.</p>				
Augmentation options				
Description	Additional network capacity (MW)	Expected cost (\$ million)	Cost classification	Lead time
<p>Option 1 (HumeLink)</p> <ul style="list-style-type: none"> A new 500 kV single-circuit line between Maragle and Bannaby A new 500 kV single-circuit line between Maragle and Wagga Wagga A new 500 kV single-circuit line between Wagga Wagga and Bannaby. Establish a new 500/330 kV substation at Maragle with 3 x 500/330/33 kV 1,500 megavolt amperes (MVA) transformers Establish a new 500/330 kV substation at Wagga Wagga with 2 x 500/330/33 kV 1,500 MVA transformers 500 kV 150 megavolt amperes reactive (MVar) Line shunt reactors at the ends of Maragle – Bannaby, Maragle – Wagga Wagga and Wagga Wagga – Bannaby lines 	<p>2,570 MW (SNSW to CNSW) REZ N7: 2,570 MW</p>	<p>To be provided by TransGrid by 30 June 2021.†</p>		
<p>Option 2</p> <ul style="list-style-type: none"> An additional new 500 kV line between Wagga Wagga and Bannaby <p>Pre-requisite: HumeLink</p>	<p>2,000 MW in both directions REZ N6: 1,400 MW</p>	820	Class 5 (±30%)	Long
<p>Option 3</p> <ul style="list-style-type: none"> A 2,000 MW HVDC bi-pole transmission system between Wagga Wagga and Bannaby <p>Pre-requisite: HumeLink</p>	<p>1,750 MW in both directions REZ N6: 1,750 MW</p>	1,760	Class 5 (±30%)	Long

Adjustment factors and risk		
Option	Adjustment factors applied	Known and unknown risks applied
Option 1 HumeLink	Pending information from TransGrid by 30 June 2021.	
Option 2	<ul style="list-style-type: none"> • Location: Regional • Land use: Grazing • Project size: Project size: 1-5 bays • Terrain: Hilly/undulating 	<ul style="list-style-type: none"> • Delivery timetable: Long • Total circuit length: above 200 km • Proportion of environmentally sensitive areas: 50%
Option 3	<ul style="list-style-type: none"> • Location: Regional • Land use: Grazing • Project size: applicable for HVDC converter station • Terrain: Hilly/undulating 	<ul style="list-style-type: none"> • Delivery timetable: Long • Total circuit length: above 200 km • Proportion of environmentally sensitive areas: 50%
		<ul style="list-style-type: none"> • Known risks: BAU • Unknown risks: Class 5
		<ul style="list-style-type: none"> • Known risks: BAU • Project complexity 'highly complex' • Unknown risks: Class 5

† The cost used in the 2020 ISP was \$2.1 billion. AEMO requests that TransGrid update this estimate by 30 June 2021.

3.9 Victoria to Southern New South Wales

Summary				
<p>A RIT-T is in progress for a large new interconnector between Victoria and New South Wales (VNI West) by AEMO and TransGrid. The 2020 ISP recommended two preferred routes for VNI West – one via Kerang and one via Shepparton.</p> <p>Five additional options are identified that can be implemented after VNI West. These options enable high transfer between New South Wales and Victoria and provide access to renewable generation in Murray River, Central North Victoria and Western Victoria REZs. The network capacity of these options is indicative and will be updated in the final Transmission Cost Report.</p>				
Existing network capability				
<p>At times of peak demand, transfer capacity is estimated to be 700 MW from VIC to SNSW. This will increase by 170 MW at times of peak demand in NSW, following completion of VNI Minor augmentation (see Section 1.4). This transfer capability is influenced by dispatch of generation at Lower Tumut and Upper Tumut and, limited by thermal capacity 330 kV lines between Upper/Lower Tumut and Canberra/Yass.</p> <p>At times of peak demand, transfer capacity is estimated to be 400 MW from SNSW to VIC. This transfer level is influenced by dispatch of Murray generation and limited by thermal capacity of Murray–Dederang 330 kV lines.</p>				
Augmentation options				
Description	Additional network capacity (MW)	Expected cost (\$ million)	Cost classification	Lead time
<p>Option 1: VNI West (Shepparton)</p> <ul style="list-style-type: none"> A new 500 kV double-circuit line from north of Ballarat to near Shepparton to Wagga Wagga. 				<i>To be provided by AEMO (Victorian TNSP) and TransGrid by 30 June 2021. †</i>
<p>Option 2: VNI West (Kerang)</p> <ul style="list-style-type: none"> A new 500 kV double-circuit line from north of Ballarat to near Bendigo to near Kerang to Dinawan to Wagga Wagga. 				<i>To be provided by AEMO (Victorian TNSP) and TransGrid by 30 June 2021. ‡</i>
<p>Option 3:</p> <ul style="list-style-type: none"> A new double-circuit 330 kV transmission line from South Morang to Dederang to Murray. Two 330/220 kV transformers at both South Morang and Dederang. Uprate Murray–Lower Tumut and Murray–Upper Tumut 330 kV lines. Cut-in Rowville–South Morang 220 kV line at South Morang. Additional reactive plants at South Morang, Dederang and Murray. <p><i>Pre-requisite: VNI West (Shepparton or Kerang)</i></p>	<p>1,500 MW in both directions</p> <p>REZ V1: 1,500 MW</p>	1,350	Class 5 (±30%)	Long

<p>Option 4:</p> <ul style="list-style-type: none"> • Convert South Morang–Dederang–Murray–Upper Tumut–Lower Tumut 330 kV lines to 500 kV design and operation by: • Replacing the two existing South Morang–Dederang–Murray 330 kV lines with new two new 500 kV lines. • Replacing the existing Murray–Upper Tumut, Murray–Lower Tumut, Upper Tumut–Lower Tumut 330 kV lines with single-circuit 500 kV lines. • Two 500/220 kV transformers at Dederang. • Two 500/330 kV transformers at Murray. • A 500/330 kV transformer at both Lower Tumut and Upper Tumut. • Additional reactive plants at South Morang, Dederang, Murray, Upper Tumut and Lower Tumut. <p><i>Pre-requisite: VNI West (Shepparton or Kerang)</i></p>	<p>1,500 MW in both directions</p> <p>REZ V1: 1,500 MW</p>	<p>2,870</p>	<p>Class 5 (±30%)</p>	<p>Long</p>
<p>Option 5:</p> <ul style="list-style-type: none"> • A new 500 kV double-circuit line from north of Melbourne to near Shepparton. • New Terminal Station in north of Melbourne. • Connect the existing South Morang–Sydenham 500 kV circuits at a new substation in north of Melbourne. • Additional reactive plants at terminal stations in north of Melbourne and near Shepparton. <p><i>Pre-requisite: VNI West (Shepparton)</i></p>	<p>1,000 MW in both directions</p> <p>REZ V6: 1,000 MW</p>	<p>710</p>	<p>Class 5 (±30%)</p>	<p>Long</p>
<p>Option 6:</p> <ul style="list-style-type: none"> • A new 500 kV double-circuit line from north of Melbourne to near Shepparton to Wagga Wagga. • New Terminal Station in north of Melbourne. • Connect the existing South Morang–Sydenham 500 kV circuits at a new substation in north of Melbourne. • Additional reactive plants at terminal stations in north of Melbourne and near Shepparton. • Two 500/220 kV transformers at a new terminal station near Shepparton. • A 500/330 kV transformer at Wagga Wagga. • Additional reactive plants at terminal stations in north of Melbourne and near Shepparton and Wagga Wagga. <p><i>Pre-requisite: VNI West (Kerang)</i></p>	<p>2,000 MW in both directions</p> <p>REZ V6: 2,000 MW</p>	<p>1,830</p>	<p>Class 5 (±30%)</p>	<p>Long</p>
<p>Option 7:</p> <ul style="list-style-type: none"> • A 2,000 MW HVDC bi-pole transmission system between north of Melbourne and Wagga Wagga. • New Terminal Station in north of Melbourne. • Connect the existing South Morang–Sydenham 500 kV circuits at a new substation in north of Melbourne. <p><i>Pre-requisite: VNI West</i></p>	<p>1,750 MW in both directions</p>	<p>2,110</p>	<p>Class 5 (±30%)</p>	<p>Long</p>

Adjustment factors and risk		
Option	Adjustment factors applied	Known and unknown risks applied
Options 1 and 2	Pending information from TransGrid by 30 June 2021.	
Option 3	<ul style="list-style-type: none"> • Location: Regional • Land use: Grazing • Project size: Project size: 11-15 bays • Terrain: Hilly/undulating and Mountainous • Delivery timetable: Long • Total circuit length: above 200 km • Proportion of environmentally sensitive areas: 50% 	<ul style="list-style-type: none"> • Known risks: BAU • Environmental offset: High • Unknown risks: Class 5 • Project complexity: High • Cultural heritage: High • Compulsory acquisition: High
Option 4	<ul style="list-style-type: none"> • Location: Regional • Land use: Grazing • Project size: Project size: 16-20 bays • Terrain: Hilly/undulating and mountainous • Delivery timetable: Long • Total circuit length: above 200 km • Proportion of environmentally sensitive areas: 50% 	<ul style="list-style-type: none"> • Known risks: BAU • Environmental offset: High • Project complexity: High • Unknown risks: Class 5 • Cultural heritage: High • Compulsory acquisition: High • Outage restrictions: High
Options 5 and 6	<ul style="list-style-type: none"> • Location: Regional • Land use: Grazing • Project size: Project size: 6-10 bays • Terrain: Flat/farmland • Delivery timetable: Long • Total circuit length: above 200 km • Proportion of environmentally sensitive areas: 50% 	<ul style="list-style-type: none"> • Known risks: BAU • Unknown risks: Class 5
Option 7	<ul style="list-style-type: none"> • Location: Regional • Land use: Grazing • Project size: applicable for HVDC converter station • Terrain: Flat/farmland • Delivery timetable: Long • Total circuit length: above 200 km • Proportion of environmentally sensitive areas: 50% 	<ul style="list-style-type: none"> • Known risks: BAU • Unknown risks: Class 5 • Project complexity 'highly complex'

† The cost used in the 2020 ISP was \$1.73 billion. AEMO requests that TransGrid and AEMO (Victorian TNSP) update this estimate by 30 June 2021.

‡ The cost used in the 2020 ISP was \$2.41 billion. AEMO requests that TransGrid and AEMO (Victorian TNSP) update this estimate by 30 June 2021.

3.10 Tasmania to Victoria

Summary				
<p>Marinus Link is a proposal that consists of two new high voltage direct current (HVDC) cables connecting Tasmania to Victoria, each with 750 MW transfer capacity and associated high voltage alternating current (HVAC) transmission. TasNetworks is currently undertaking a RIT-T to identify the preferred option for the project. The PADR, the second report of the RIT-T, was published in December 2019. In November 2020, TasNetworks published a supplementary analysis report, with updated cost benefit analysis using the 2020 ISP assumptions.</p> <p>TasNetworks proposes to implement Marinus Link in two stages.</p>				
Existing network capability				
<p>The transfer capacity between Tasmania and Victoria is limited by thermal capability of Basslink (HVDC system between Tasmania and Victoria).</p> <p>Transfer capacity between Tasmania and Victoria is limited to 478 MW in both directions at times of peak demand, summer typical and winter reference periods.</p>				
Augmentation options				
Description	Additional network capacity (MW)	Expected cost (\$ million)	Cost classification	Lead time
<p>Option 1 (Marinus Link – Stage 1)</p> <ul style="list-style-type: none"> A 750 MW monopole high voltage direct current (HVDC) link between Burnie area in Tasmania and Hazelwood area in Victoria. A 220 kV double-circuit AC line from Palmerston to Sheffield to the Burnie area <p>TasNetworks to provide an update from RIT-T works by 30 June 2021.</p>	<p>Marinus Link: 750 in both directions.</p> <p>Basslink and Marinus Link Stage 1 combined: TAS to VIC 1,228 VIC to TAS 978</p> <p>REZ T3: 540 MW</p>	<p><i>Pending information from TasNetworks by 30 June 2021.†</i></p>		
<p>Option 2 (Marinus Link – Stage 2)</p> <ul style="list-style-type: none"> A second 750 MW monopole HVDC link between Burnie area in Tasmania and Hazelwood area in Victoria. A 220 kV double-circuit ac line from Staverton to Hampshire to the Burnie area. <p>TasNetworks to provide an update from RIT-T works by 30 June 2021.</p>	<p>Marinus Link: 750 in both directions.</p> <p>Basslink and Marinus Link Stages 1 and 2 combined: TAS to VIC 1,978 VIC to TAS 1,728</p> <p>REZ T2: 600 MW</p>	<p><i>Pending information from TasNetworks by 30 June 2021.†</i></p>		
Adjustment factors and risk				
Option	Adjustment factors applied	Known and unknown risks applied		
Options 1 and 2	To be provided by TasNetworks by 30 June 2021.			

† The cost used in the 2020 ISP was \$1,845 million for stage 1 and \$1,310 million for stage 2. AEMO requests that TasNetworks update this estimate by 30 June 2021.

3.11 New South Wales to South Australia

Summary				
<p>Project EnergyConnect (PEC) is a new double-circuit 330 kV transmission line from Robertstown in South Australia to Buronga, Dinawan and Wagga Wagga in New South Wales, and an additional 220 kV line between Buronga and Red Cliffs in Victoria.</p> <p>ElectraNet and TransGrid have completed the RIT-T and submitted the revised Contingent Project Application (CPA) in April 2021. PEC is pending the AER's decision and it will be modelled as a flow path augmentation option if it does not receive regulatory approval.</p>				
Existing network capability				
<p>Transfer capability between South Australia and Victoria/New South Wales is limited by thermal and stability limits of the Victoria to South Australia interconnectors (i.e. Heywood and Murraylink).</p> <p>Combined notional maximum transfer between VIC and SA is 820 MW from VIC to SA and 700 MW from SA to VIC at times of peak demand, summer typical and winter reference periods.</p>				
Augmentation options				
Description	Additional network capacity (MW)	Expected cost (\$ million)	Cost classification	Lead time
<p>Option 1 – Project EnergyConnect: (Anticipated Project† - see Section 1.4)</p> <ul style="list-style-type: none"> • A new 330 kV double-circuit line from Wagga Wagga to Dinawan to Buronga to Bunday. • A new 275 kV line between Bunday and Robertstown. • Rebuild of the existing 220 kV line from Red Cliffs to Buronga as a double-circuit 220 kV line. • New substations at Dinawan and Bunday. • New 330 kV phase shifting transformers at Buronga. • New 330/275 kV transformers at Bunday and 330/220 kV transformers at Buronga. • Turning the existing 275 kV line between Para and Robertstown into Tungkillio. • Static and dynamic reactive plant at Bunday, Robertstown, Buronga, Dinawan. • A special protection scheme to detect and manage the loss of either of the AC interconnectors connecting to South Australia. 	<p>PEC: 800 MW in both directions</p> <p>VIC-SA (Heywood): 750 MW in both directions</p> <p>PEC and VIC-SA (Heywood) combined: 1,300 (VIC/NSW to SA) 1,450 (SA to VIC/NSW)</p> <p>REZ S2: 800 MW REZ N5: 600 MW</p>	\$2,150 to \$2,330 ‡	Not applicable – anticipated project†	Medium
Adjustment factors and risk				
Option	Adjustment factors applied	Known and unknown risks applied		
Option 1	Not applicable – anticipated project†			

† If the Contingent Project Applications for Project EnergyConnect are not approved, AEMO will model this project as an augmentation option rather than a “committed” or “anticipated” project. See Section 1.4 for more information on anticipated and committed projects. See AER. *TransGrid and ElectraNet – Project EnergyConnect contingent project*, available at <https://www.aer.gov.au/networks-pipelines/determinations-access-arrangements/contingent-projects/transgrid-and-electranet-%E2%80%93-project-energyconnect-contingent-project>.

‡ On 18 December 2020, the AER's preliminary assessment for the prudent and efficient capital cost of this project was \$2.15 billion. In April 2021, ElectraNet and TransGrid submitted revised contingent project applications with a total project cost of \$2.33 billion.

4. Renewable energy zones

REZs are areas in the NEM where clusters of large-scale renewable energy can be efficiently developed, promoting economies of scale in high-resource areas, and capturing important benefits from geographic and technological diversity in renewable resources. The geographic boundaries, resource quality and existing transmission limits for each REZ were determined through the initial 2021 Draft IASR consultation.

This chapter outlines network augmentation options to increase the network hosting capacity¹⁶ of REZs. The following information is presented for each augmentation option:

- A description of the option.
- The expected increase in transfer capacity.
- The project cost, including the class of the estimate and associated accuracy.
- An overview of characteristics which are key cost drivers.

Section 2.4.6 of AEMO's *Draft ISP Methodology*¹⁷ provides an overview of how AEMO proposes using these augmentation options and costs in the ISP modelling.

4.1 Overview

REZ network augmentations are designed to allow connection of new generation to the existing network and overcome expected network congestion. The full list of candidate REZs considered for the 2022 ISP is shown in Figure 9.

Figure 10 (in Section 5) highlights the allocation of costs associated with REZ network augmentation costs shown in this section, and delineates these from costs associated with generator connections. REZ network augmentations are designed to allow connection of new generation to the existing network and overcome expected network congestion.

Where network congestion can result due to the combined output from multiple REZs, grouped REZ network augmentation options are defined (see Section 4.3.10 and Section 4.4.10).

For any scenario where load centres may emerge near ports as described in Section 4.9.3 of the *Draft IASR*¹⁸, AEMO is proposing to use REZ network expansion costs based on those calculated for the Q9 Banana REZ.

The following sections include tables that provide an overview of the characteristics of each network development option. Section 3.2 explains the terminology used in these tables.

¹⁶ The "hosting capacity" of a REZ refers to the amount of generation that can be connected within the REZ and efficiently supplied to load centres.

¹⁷ At <https://www.aemo.com.au/consultations/current-and-closed-consultations/isp-methodology>.

¹⁸ AEMO, *Draft 2021 Input, Assumptions and Scenarios Report*, at https://www.aemo.com.au/-/media/files/electricity/nem/planning_and_forecasting/inputs-assumptions-methodologies/2021/draft-2021-inputs-assumptions-and-scenarios-report.pdf?la=en

Figure 9 Candidate renewable energy zones

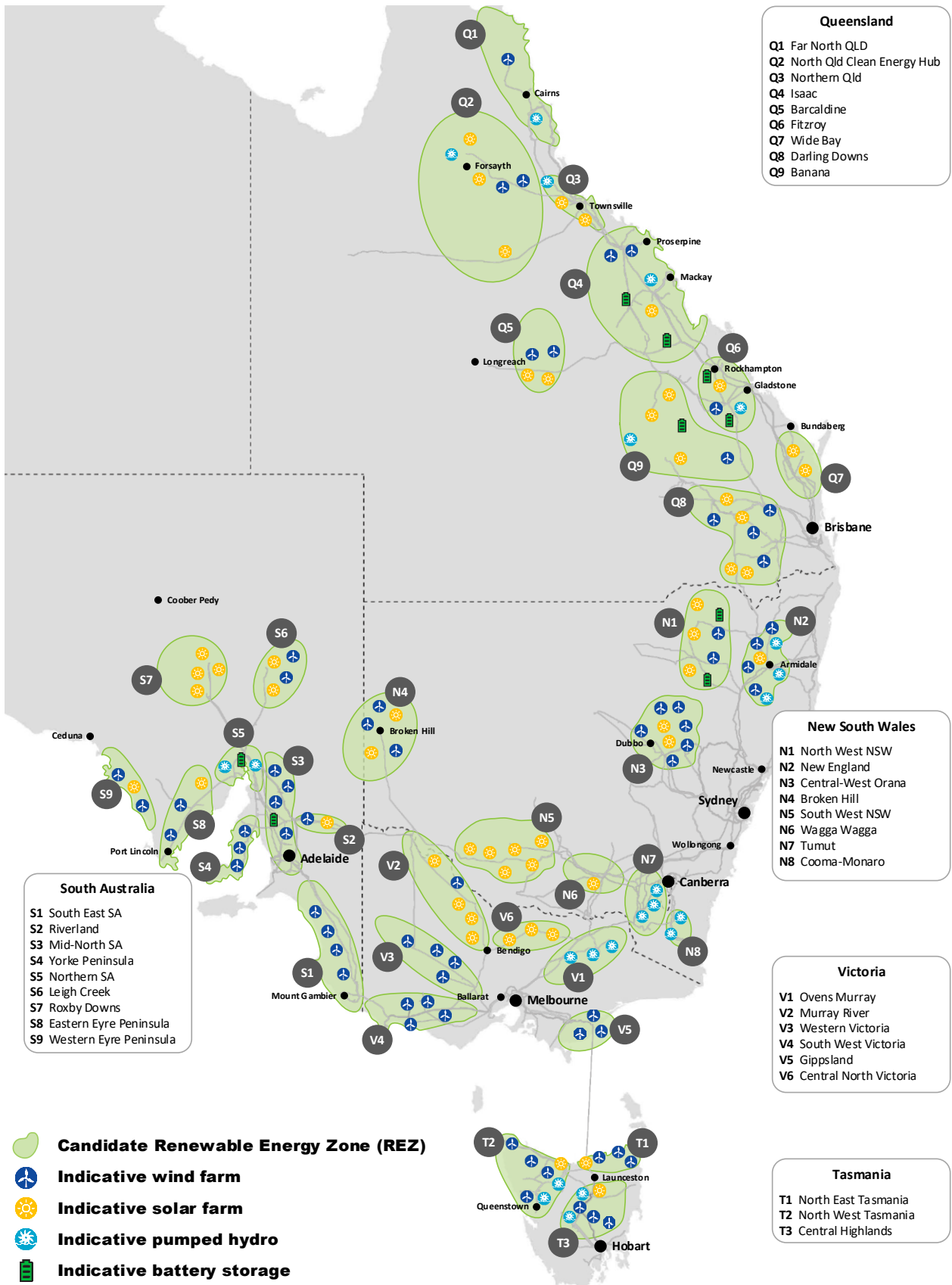

4.2 New South Wales

4.2.1 North West New South Wales (N1)

Summary				
<p>The North-West New South Wales (NWNSW) REZ is located to the west of the existing Queensland – New South Wales (QNI) interconnector. The capacity of this REZ is supported by QNI Medium and QNI Large upgrade proposals (see Section 3.5). While this zone has high quality solar resources, the wind resource is estimated to be inadequate for wind farm development.</p> <p>As generation further increases in NWNSW and New England REZs, increased connection capacity between the two REZs is likely to be required. The sharing of resources across the network augmentation will allow for better transmission utilisation and reduction in transmission build.</p>				
Existing network capability				
<p>The existing 132 kV network is weak and would require significant network upgrades to accommodate VRE greater than the current hosting capacity of approximately 100 MW.</p>				
Augmentation options				
Description	Additional network capacity (MW)	Expected cost (\$ million)	Cost classification	Lead time
<p>Option 1:</p> <ul style="list-style-type: none"> Establish two new 500 kV transmission lines from NWNSW (near Moree) to Orana. Establish a new 330 kV single-circuit from NWNSW REZ to Tamworth. Establish a new 330 kV single-circuit from NWNSW REZ to Sapphire. 	<p>To be provided by TransGrid by 30 June 2021.</p>			
Adjustment factors and risk				
Option	Adjustment factors applied	Known and unknown risks applied		
Option 1	To be provided by TransGrid by 30 June 2021.			

4.2.2 New England (N2)

Summary				
<p>New England REZ is located to the east of and along the existing QNI interconnector. The capacity of this REZ is supported by QNI Medium and QNI Large upgrade proposals†.</p> <p>This REZ has moderate to good wind and solar resources in close proximity to the 330 kV network. Interest in the area includes large scale solar and wind generation as well as pumped hydro generation.</p> <p>As generation further increases in North West New South Wales and New England REZs, increased connection capacity between the two REZs is likely to be required. The sharing of resources across the network augmentation will allow for better transmission utilisation and reduction in transmission build</p>				
Existing network capability				
<p>The existing network capacity, following completion of the committed QNI minor upgrade (see Section 3.5), is limited by transient and voltage stability on the circuits between Bulli Creek, Sapphire and Dumaresq. Thermal limits on the 330 kV circuits between Armidale, Tamworth, Muswellbrook and Liddell can also restrict flows on this network.</p>				
Augmentation options				
Description	Additional network capacity (MW)	Expected cost (\$ million)	Cost classification	Lead time
<p>Option 1:</p> <ul style="list-style-type: none"> Two new 500 kV transmission lines from south of Armidale to NWNSW to Orana via Boggabri. 	To be provided by TransGrid by 30 June 2021.			
<p>Option 2:</p> <ul style="list-style-type: none"> Two new 500 kV lines from south of Armidale to Bayswater via a new substation west of Tamworth, and A 330 kV single-circuit from Dungowan area to Tamworth. 	To be provided by TransGrid by 30 June 2021.			
<p>Option 3:</p> <ul style="list-style-type: none"> A new 330 kV double-circuit line from south of Armidale to Liddell. 	1,600	820	Class 5 (±30%)	Long
<p>Option 4:</p> <ul style="list-style-type: none"> A new 500 kV single-circuit line between new substations in Orana and NWNSW REZ and a new 500 kV single-circuit from Bayswater to south of Armidale to NSNSW REZ. 	2,700	1,650	Class 5 (±30%)	Long
<p>Option 5:</p> <ul style="list-style-type: none"> A 2,000 MW bi-pole HVDC transmission system between Bayswater and south of Armidale. 	2,300	1,780	Class 5 (±30%)	Long
Adjustment factors and risk				
Option	Adjustment factors applied	Known and unknown risks applied		
Options 1 and 2	To be provided by TransGrid by 30 June 2021.			

Options 3 and 4	<ul style="list-style-type: none"> • Location: Remote • Land use: Grazing • Project size: Project size: 1-5 bays 	<ul style="list-style-type: none"> • Delivery timetable: Long • Total circuit length: above 200 km • Proportion of environmentally sensitive areas: 50% 	<ul style="list-style-type: none"> • Known risks: BAU • Unknown risks: Class 5
Option 5	<ul style="list-style-type: none"> • Location: Remote • Land use: Grazing • Project size: applicable for HVDC converter station 	<ul style="list-style-type: none"> • Delivery timetable: Long • Total circuit length: above 200 km • Proportion of environmentally sensitive areas: 50% 	<ul style="list-style-type: none"> • Known risks: BAU • Unknown risks: Class 5 • Project complexity: Highly complex

† Options shown are a subset of the Central New South Wales to Northern New South Wales flow path options, described in Section 3.6.

4.2.3 Central West Orana (N3)

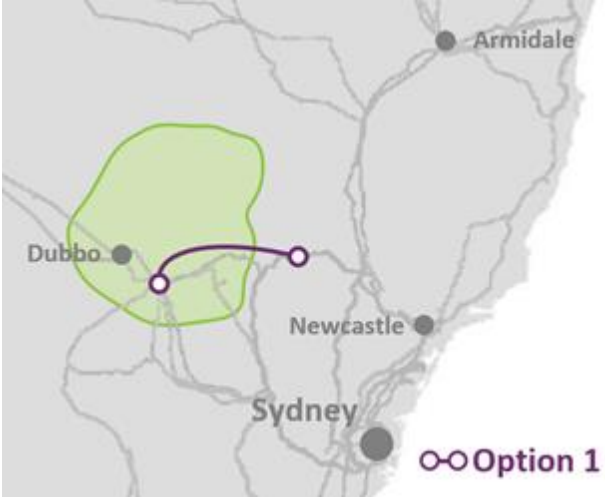
Summary				
<p>The Central West Orana REZ is electrically close to the Sydney load centre and has moderate wind and solar resources.</p> <p>Central West Orana REZ has been identified by the New South Wales Government as the state's first pilot REZ†. The <i>NSW Electricity Infrastructure Investment Act 2020</i> legislates the REZ be declared with an intended 3,000 MW of transmission network capacity within the Central-West Orana region of the state.</p> <p>Due to the nature of the project, which is currently going through consultation on corridor selection, specific information on the project is not able to be provided, but it is expected to include new transmission lines connecting to a 500 kV and 330 kV loop in the vicinity of the Central-West Orana REZ indicative location.</p>		 <p>Note: The transmission study corridor is currently under consultation. More information is available at https://energy.nsw.gov.au/renewables/renewable-energy-zones.</p>		
Existing network capability				
<p>The project to establish the Central West Orana REZ is considered anticipated, and as such the existing network capability is approximately 3,000 MW</p>				
Augmentation options				
Description	Additional network capacity (MW)	Expected cost (\$ million)	Cost classification	Lead time
<p>Options to be considered within the bounds of the anticipated project include:</p> <ul style="list-style-type: none"> New transmission lines connecting to 500 kV and 330 kV network in vicinity of the Orana REZ indicative location. 	<p><i>Anticipated Project (See Section 1.4)</i></p>			

† See <https://energy.nsw.gov.au/renewables/renewable-energy-zones#-centralwest-orana-renewable-energy-zone-pilot->.

4.2.4 Broken Hill (N4)

Summary				
<p>Broken Hill REZ has excellent solar resources. It is connected to the New South Wales grid via a 220 kV line from Buronga with an approximate length of 270 km.</p>				
Existing network capability				
<p>Due to the existing large-scale solar and wind generation projects already operating in this REZ, there is no additional hosting capacity within this REZ.</p> <p>Further development of new generation development in this REZ requires significant transmission network augmentation due to the distance of the REZ from the main transmission paths of the shared network.</p>				
Augmentation options				
Description	Additional network capacity (MW)	Expected cost (\$ million)	Cost classification	Lead time
<p>Option 1:</p> <ul style="list-style-type: none"> 500 kV double-circuit line from Bannaby – Broken Hill (>850 km). Two mid-point switching stations and reactive plant. 	2,000	3,500	Class 5 (±30%)	Long
<p>Option 2:</p> <ul style="list-style-type: none"> 500 kV double-circuit HVDC line from Bannaby – Broken Hill (>850 km). 	2,000	3,300	Class 5 (±30%)	Long
Adjustment factors and risk				
Option	Adjustment factors applied	Known and unknown risks applied		
Option 1	<ul style="list-style-type: none"> Delivery timetable: Long Project network element size: Above 200 km, no. of bays 21-25 Location (regional/distance factors): Remote (except Bannaby which is Regional) 	<ul style="list-style-type: none"> Land use: Grazing Proportion of environmentally sensitive areas: 0% 	<ul style="list-style-type: none"> Known risks: BAU 	<ul style="list-style-type: none"> Unknown risks: Class 5
Option 2	<ul style="list-style-type: none"> Delivery timetable: Long Project network element size: Above 200 km, no. of total Bays above 31 / applicable for HVDC converter station project 	<ul style="list-style-type: none"> Land use: Grazing Proportion of environmentally sensitive areas: 0% Location (regional/distance factors): Remote 	<ul style="list-style-type: none"> Known risks: BAU Unknown risks: Class 5 	<ul style="list-style-type: none"> Project complexity: Highly complex

4.2.5 South West NSW (N5)

Summary				
<p>The South West REZ has good solar resource and incorporates the Darlington Point substation which marks the transition from 330 kV to 220 kV. Further west, the 220 kV links to North West Victoria and Broken Hill.</p> <p>This REZ is one of three REZs which are being targeted for further development under the NSW Electricity Infrastructure Roadmap.</p>				
Existing network capability				
<p>Due to the existing large-scale solar projects already operating within this REZ, there is no additional hosting capacity. Further development of new generation in this REZ requires network augmentation towards the greater Sydney load centre.</p> <p>The capacity within this REZ and ability to transfer energy from the REZ to the main load centres in the greater Sydney area will be improved with the construction of the proposed Project EnergyConnect (see Section 3.11) and Humelink (see Section 3.8) projects. Furthermore, one option for VNI West (Kerang route) would also increase the hosting capacity of this REZ (see Section 3.9).</p>				
Augmentation options				
Description	Additional network capacity (MW)	Expected cost (\$ million)	Cost classification	Lead time
<p>Option 1:</p> <ul style="list-style-type: none"> Rebuild 330 kV Darlington Point – Wagga to a high capacity double-circuit line. 500 kV single-circuit line from Bannaby – Wagga. 500/330 kV 1,500 MVA transformer at Wagga. 	1,400	1,200	Class 5 (±30%)	Long
<p>Option 2:</p> <ul style="list-style-type: none"> Establish a new Darlington Point to Dinawan 330 kV transmission line. <p><i>Pre-requisite: Project EnergyConnect (see Section 3.11) ‡</i></p>	600	<i>To be provided by TransGrid by 30 June 2021. †</i>		
Adjustment factors and risk				
Option	Adjustment factors applied		Known and unknown risks applied	
Option 1	<ul style="list-style-type: none"> Delivery timetable: Long Project network element size: Above 200 km, no. of bays 6-10 Location (regional/distance factors): Regional 	<ul style="list-style-type: none"> Land use: Grazing Proportion of environmentally sensitive areas: 0% 	<ul style="list-style-type: none"> Known risks: BAU Decommissioning not costed 	<ul style="list-style-type: none"> Unknown risks: Class 5
Option 2	<ul style="list-style-type: none"> Provided by TransGrid 		<ul style="list-style-type: none"> Provided by TransGrid 	

† The cost presented in TransGrid's RIT-T was \$145-225 million. AEMO requests that TransGrid update this estimate by 30 June 2021.

‡ Improving stability in south-western NSW RIT-T – Project Specification Consultation Report, TransGrid, 30 July 2020, at https://transgrid.com.au/what-we-do/projects/regulatory-investment-tests/Documents/TransGrid%20PSCR_Stabilising%20SW%20NSW.pdf.

4.2.6 Wagga Wagga (N6)

Summary				
<p>This REZ extends to the west of Wagga Wagga, and has moderate wind and solar resources.</p>				
Existing network capability				
<p>There is no additional hosting capacity within this REZ. Further development of new generation in this REZ requires network augmentation towards the greater Sydney load centre.</p> <p>Additionally, the capacity within this REZ and ability to transfer energy from the REZ to the main load centres in the greater Sydney area is improved with the proposed HumeLink project. Options shown do not depend upon HumeLink as a pre-requisite.</p>				
Augmentation options				
Description	Additional network capacity (MW)	Expected cost (\$ million)	Cost classification	Lead time
<p>Option 1:</p> <ul style="list-style-type: none"> • 500 kV double-circuit line from Bannaby – Wagga. • Two 500/330 kV 1,500 MVA transformers at Wagga. 	2,000	1,030	Class 5 (±30%)	Long
<p>Option 2:</p> <ul style="list-style-type: none"> • 500 kV single-circuit line from Bannaby – Wagga. • One 500/330 kV 1,500 MVA transformer at Wagga. 	1,400	790	Class 5 (±30%)	Long
Adjustment factors and risk				
Option	Adjustment factors applied	Known and unknown risks applied		
Option 1 and 2	<ul style="list-style-type: none"> • Delivery timetable: Long • Land use: Grazing • Project network element size: Above 200 km, no. of bays 1-5 for Option 1 and 6-10 for Option 2 • Proportion of environmentally sensitive areas: 0% • Location (regional/distance factors): Regional 	<ul style="list-style-type: none"> • Known risks: BAU • Unknown risks: Class 5 		

4.2.7 Tumut (N7)

Summary				
<p>The Tumut REZ has been identified due to the potential for additional pumped hydro generation in association with Snowy 2.0 and the proposed actionable ISP HumeLink (see Section 3.8).</p> <p>The HumeLink project which is currently undergoing a RIT-T¹⁹ will enable the connection of more than 2,000 MW of pumped hydro generation (Snowy 2.0) in the Tumut REZ area.</p>				
Existing network capability				
<p>There is no additional hosting capacity within this REZ. Further development of new generation in this REZ is associated with the HumeLink project.</p> <p>Currently the 330 kV transmission network around Lower and Upper Tumut is congested during peak demand periods. A careful balance of generation from the existing hydro units and flow between Victoria and New South Wales is required to prevent overloads within this area.</p>				
Augmentation options				
Description	Additional network capacity (MW)	Expected cost (\$ million)	Cost classification	Lead time
HumeLink (Actionable ISP 2020 project): see Section 3.8	2,570 (SNSW to CNSW)	See Section 3.8.		
Adjustment factors and risk				
Option	Adjustment factors applied	Known and unknown risks applied		
HumeLink	<ul style="list-style-type: none"> To be provided by TransGrid 	<ul style="list-style-type: none"> To be provided by TransGrid 		

¹⁹ See <https://www.transgrid.com.au/humelink>.

4.2.8 Cooma-Monaro (N8)

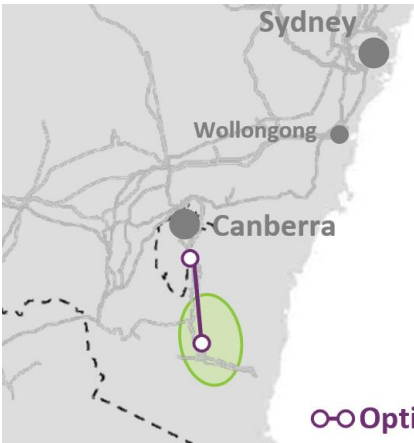
Summary				
<p>The Cooma-Monaro REZ has been identified for its pumped hydro potential. This REZ has moderate to good quality wind resources.</p>				
Existing network capability				
<p>The existing 132 kV network connecting Cooma-Monaro REZ to Canberra, Williamsdale and Mungah can accommodate approximately 200 MW of additional generation.</p>				
Augmentation options				
Description	Additional network capacity (MW)	Expected cost (\$ million)	Cost classification	Lead time
<p>Option 1:</p> <ul style="list-style-type: none"> 132 kV single-circuit Williamsdale to Cooma-Monaro substation (located near generation interest). 	200	110	Class 5 (±30%)	Medium
Adjustment factors and risk				
Option	Adjustment factors applied	Known and unknown risks applied		
Option 1	<ul style="list-style-type: none"> Delivery timetable: Long Land use: Grazing Project network element size: Above 10-100 km, no. of bays 1-5 Proportion of environmentally sensitive areas: 0% Location (regional/distance factors): Regional 	<ul style="list-style-type: none"> Known risks: BAU Unknown risks: Class 5 		

4.2.9 Hunter Central Coast and Illawarra

Summary
<p>The NSW Government is in the early stages of planning for two new REZs in the Hunter-Central Coast and Illawarra regions of NSW, as set out under the <i>NSW Electricity Infrastructure Act 2020</i>[†].</p> <p>The NSW Government is in the early stages of planning the geographic area and network design and as such network augmentation options are not yet developed.</p>
Existing network capability
<p>To be determined at a later date.</p>

[†] See <https://www.legislation.nsw.gov.au/view/html/inforce/current/act-2020-044#statusinformation>.

4.3 Queensland

4.3.1 Far North Queensland (Q1)

Summary				
<p>The Far North Queensland (FNQ) REZ is at the most northerly section of Powerlink's network. It has excellent wind and moderate solar resources and has existing hydroelectric power stations.</p> <p>Four options are proposed that progressively increase network capacity, and allow for upgrades based on where generation develops.</p>				
Existing network capability				
<p>Maximum export capability from the FNQ REZ is limited by voltage stability for a contingency of a Ross to Chalumbin 275 kV circuit. The existing network will allow for approximately 700 MW of VRE to be connected.</p> <p>Output from this REZ can also be limited by network capacity further south which can result in the need for additional network augmentations. Output from this REZ is included in the NQ1, NQ2 and NQ3 Group Constraints (see section 4.3.10) to take this into account.</p> <p>Powerlink has also recently announced† plans for upgrades to transmission networks in the Q1 REZ as part of the Northern Queensland Renewable Energy Zone.</p>				
Augmentation options				
Description	Additional network capacity (MW)	Expected cost (\$ million)	Cost classification	Lead time
<p>Option 1:</p> <ul style="list-style-type: none"> Establish a new 275 kV substation north of Millstream. Build a 275 kV double-circuit line from Chalumbin to Millstream. Rebuild the double-circuit Chalumbin–Ross 275 kV line at a higher capacity (possibly timed with asset replacement). Build additional Chalumbin–Ross 275 kV double-circuit tower but string and energise as a single-circuit line. 	1,000	1,120	Class 5 (±30%)	Long
<p>Option 2:</p> <ul style="list-style-type: none"> Establish a new 275 kV substation in the Lakeland area Build a double-circuit 275 kV line from Walkamin to the new substation near Lakeland. Build a new 275 kV Chalumbin–Walkamin single-circuit line. Rebuild the double-circuit Chalumbin–Ross 275 kV line at a higher capacity (possibly timed with asset replacement). Build additional Chalumbin–Ross 275 kV double-circuit tower but string and energise as a single-circuit line. 	1,000	1,670	Class 5 (±30%)	Long

Option 3: <ul style="list-style-type: none"> String and energise the other Chalumbin-Ross 275 kV additional circuit. <i>Pre-requisite: Option 1 or 2.</i>	400	140	Class 5 ($\pm 30\%$)	Medium
Adjustment factors and risk				
Option	Adjustment factors applied		Known and unknown risks applied	
Option 1	<ul style="list-style-type: none"> Estimated 75% proportion of project in environmentally sensitive areas 'Remote' location for substation near Lakeland Total circuit length 'above 200 km', project size 1 – 5 bays 		<ul style="list-style-type: none"> Known risks: BAU Unknown risks: Class 5 	
Option 2	<ul style="list-style-type: none"> Estimated 75% proportion of project in environmentally sensitive areas 'Regional' location for Millstream Substation Total circuit length 'above 200 km', project size 1 – 5 bays 		<ul style="list-style-type: none"> Known risks: BAU Unknown risks: Class 5 	
Option 3	<ul style="list-style-type: none"> 'Regional' location for circuit Total circuit length 'above 200 km', project size 1 – 5 bays 		<ul style="list-style-type: none"> Known risks: BAU Unknown risks: Class 5 	

† Powerlink, Queensland Renewable Energy Zones, at: <https://www.powerlink.com.au/queensland-renewable-energy-zones>.

4.3.2 North Queensland Clean Energy Hub (Q2)

Summary				
<p>The Clean Energy Hub REZ is at the north-western section of Powerlink's network, and has excellent wind and solar resources.</p> <p>Two options are proposed that progressively increase network capacity and allow for upgrades based on when generation develops.</p>				
Existing network capability				
<p>Currently the REZ is supplied via a 132 kV line from Ross. Interest in this area includes the development of Kidston pumped storage project which Powerlink has recently received a 'Notice to Proceed' to develop a single circuit 275 kV line†.</p> <p>Output from this REZ can also be limited by network capacity further south which can result in the need for additional network augmentations. Output from this REZ is included in the NQ1, NQ2 and NQ3 group constraints (see Section 4.3.10).</p>				
Augmentation options				
Description	Additional network capacity (MW)	Expected cost (\$ million)	Cost classification	Lead time
Option 1: <ul style="list-style-type: none"> Build additional 275 kV single-circuit line from Kidston Substation to midpoint switching station 	500	410	Level 5 (±30%)	Long
Adjustment factors and risk				
Option	Adjustment factors applied	Known and unknown risks applied		
Option 1	<ul style="list-style-type: none"> 'Remote' location for Kidston Substation in 'Desert' environment. Total circuit length '150 - 200 km', project size 1-5 bays Circuit built at cyclone standard 	<ul style="list-style-type: none"> Known risks: BAU Unknown risks: Class 5 		

† Powerlink, Genex-Kidston connection project, at: <https://www.powerlink.com.au/projects/genex-kidston-connection-project>.

4.3.3 Northern Queensland (Q3)

Summary				
<p>The North Queensland REZ encompasses Townsville and the surrounding area. It has good quality solar and wind resources and is situated close to the high capacity 275 kV network. There are already a number of existing large-scale solar generation projects operational within this REZ.</p>				
Existing network capability				
<p>Due to the existing high voltage infrastructure there are no augmentation options specifically for this REZ. Existing network capacity can allow for up to approximately 1,800 MW of new generator connections, shared between Q1, Q2 and Q3.</p> <p>Output from this REZ can be limited by network capacity further south which can result in the need for additional network augmentations. Output from this REZ is included in the NQ1, NQ2 and NQ3 group constraints (see Section 4.3.10).</p>				
Augmentation options				
Description	Additional network capacity (MW)	Expected cost (\$ million)	Cost classification	Lead time
See Section 4.3.10 (NQ1).				

4.3.4 Isaac (Q4)

Summary				
<p>The Isaac REZ has good wind and solar resources covering Collinsville and Mackay, and has a number of large-scale solar generation projects already in operation.</p> <p>There are numerous potential pumped hydro locations to the north east and south east of Nebo. This REZ has a good diversity of resources – wind, solar and storage. Locating storage in this zone could maximise transmission utilisation towards Brisbane.</p>				
Existing network capability				
<p>The Isaac REZ forms part of the NQ transmission backbone from Nebo to Strathmore. Due to the existing high voltage infrastructure there are no augmentation options specifically for this REZ. The associated augmentations are the NQ2 and NQ3 group constraint augmentations that facilitate power Q1 to Q5 to be transmitted south to the load centres (see Section 4.3.10).</p> <p>The network has the ability to support up to 2,500 MW of generation across the REZs in northern Queensland depending on the level of storage in these REZs.</p>				
Augmentation options				
Description	Additional network capacity (MW)	Expected cost (\$ million)	Cost classification	Lead time
See Section 4.3.10 (NQ2 and NQ3).				

4.3.5 Barcaldine (Q5)

Summary				
<p>This REZ has excellent solar resources and moderate wind resources, but is located a long way from the Queensland transmission backbone. Barcaldine REZ has not been identified as having significant potential pumped hydro capability.</p>				
Existing network capability				
<p>This REZ is fed via a 132 kV line from Lilyvale. A total of 100 MW of inverter-based generation is already installed on this long radial 132 kV network.</p> <p>Currently there is no spare network capacity available within the Barcaldine REZ. Output from this REZ can be limited by network capacity further south which can result in the need for additional network augmentations. Output from this REZ is included in the NQ2 and NQ3 group constraints to take this into account (see Section 4.3.10).</p>				
Augmentation options				
Description	Additional network capacity (MW)	Expected cost (\$ million)	Cost classification	Lead time
<p>Option 1: (Single-circuit)</p> <ul style="list-style-type: none"> Establish a 275 kV substation in the Barcaldine region Build a 300 km 275 kV single-circuit line on double-circuit towers from Lilyvale to Barcaldine. 	500	660	Level 5	Long
<p>Option 2: (Double-circuit)</p> <ul style="list-style-type: none"> String the second circuit on the towers established in Option 1. Additional substation bays and reactors. <p>Pre-requisite: Option 1</p>	1,000	186	Level 5	Long
Adjustment factors and risk				
Option	Adjustment factors applied	Known and unknown risks applied		
Option 1: Single-circuit	<ul style="list-style-type: none"> 'Remote' location for Barcaldine Substation in 'Desert' environment. Total circuit length '200 km+', project size 1 – 5 bays Circuit built at cyclone standard 	<ul style="list-style-type: none"> Known risks: BAU Unknown risks: Class 5 		
Option 2: Double-circuit	<ul style="list-style-type: none"> 'Remote' location for Kidston Substation in 'Desert' environment. Total circuit length '200 km+', project size 1 – 5 bays Circuit built at cyclone standard 	<ul style="list-style-type: none"> Known risks: BAU Unknown risks: Class 5 		

4.3.6 Fitzroy (Q6)

Summary				
<p>The Fitzroy REZ is in Central Queensland and covers a strong part of the network where Gladstone and Callide generators are connected. This REZ has good solar and wind resources.</p>				
Existing network capability				
<p>The network has the ability to support up to 2,100 MW of power transfer from Central Queensland to Southern Queensland which is defined as the transient stability limit of the network (for a contingency of Calvale–Halys 275 kV circuit).</p> <p>Due to the existing high voltage infrastructure, there are no augmentation options specifically for this REZ. The associated augmentations are the NQ3 group constraint augmentations that facilitate power from Q1 to Q6 to be transmitted south to the load centres (see Section 4.3.10).</p>				
Augmentation options				
Description	Additional network capacity (MW)	Expected cost (\$ million)	Cost classification	Lead time
See Section 4.3.10 (NQ3).				

4.3.7 Wide Bay (Q7)

Summary				
<p>The Wide Bay area has moderate solar resources and already has a number of large solar PV generators operational within the REZ.</p> <p>There is difficulty getting easements in this residential area, and hence this would require a rebuild of the existing single-circuit lines as double-circuits to help reduce those challenges around obtaining easements should the generation interest exceed the current network capacity.</p>				
Existing network capability				
<p>The existing network facilitates power transfer from Central Queensland to the load centre in Brisbane. This is a 275 kV transmission backbone and can support up to approximately 500 MW of new generation connecting in the area north of Brisbane up to Gympie.</p>				
Augmentation options				
Description	Additional network capacity (MW)	Expected cost (\$ million)	Cost classification	Lead time
<p>Option 1:</p> <ul style="list-style-type: none"> Rebuild Woolooga – Palmwoods – South Pine 275 kV single-circuit line as a high capacity double-circuit line 100 MVar reactor for voltage control 	900	420	Level 5	Long
<p>Option 2:</p> <ul style="list-style-type: none"> Rebuild Woolooga – South Pine 275 kV single circuit line as a high capacity double-circuit line 100 MVar reactor for voltage control 	900	400	Level 5	Long
Adjustment factors and risk				
Option	Adjustment factors applied	Known and unknown risks applied		
Option 1	<ul style="list-style-type: none"> Circuit terrain: Hilly/undulating Total Circuit length: < 200 km Land Use: Regional 	<ul style="list-style-type: none"> Known risks: BAU Unknown risks: Class 5 Line decommissioning costs not included 		
Option 2	<ul style="list-style-type: none"> Circuit terrain: Hilly/undulating Total Circuit length: < 200 km Land Use: Regional 	<ul style="list-style-type: none"> Known risks: BAU Unknown risks: Class 5 Line decommissioning costs not included 		

4.3.8 Darling Downs (Q8)

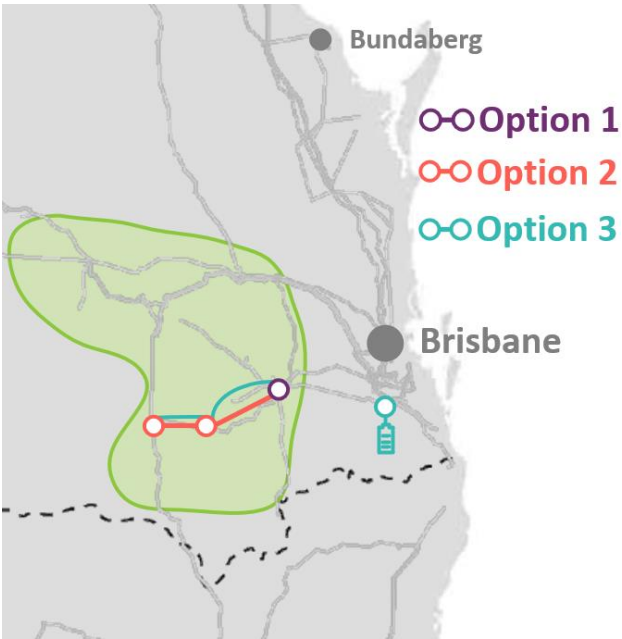
Summary				
<p>The Darling Downs REZ extends from the border of NSW around Dumaresq, up to Columboola within the Surat region of Queensland, and has good solar and wind resources. A number of large solar and wind projects are already connected within the zone.</p>				
Existing Network Capability				
<p>The Darling Downs REZ has high network capacity, and is near QNI and Brisbane. Furthermore, the ultimate retirement of generation within this REZ will allow for increased VRE connections.</p> <p>Under high demand conditions, this corridor can only facilitate 1,300 MW into the greater Brisbane area. Augmentations in this REZ involve reinforcement of the corridor between Bulli – Millmerran – Middle Ridge in order to support the export of power both to the South-East Queensland load centres and to facilitate flow across QNI. Additionally, the Middle Ridge site is very constrained – further investigation is required to determine the feasibility of expanding this substation.</p>				
Augmentation options				
Description	Additional network capacity (MW)	Expected cost (\$ million)	Cost classification	Lead time
<p>Option 1:</p> <ul style="list-style-type: none"> Replace existing 1,300 MVA 330/275 kV transformer at Middle Ridge with 1,500 MVA 330/275 kV transformer. 	200	34	Level 5	Medium
<p>Option 2:</p> <ul style="list-style-type: none"> 140 km single-circuit 330 kV from Bulli Creek-Millmerran-Middle Ridge. 330/275 kV transformer at Middle Ridge with associated shunt capacitor. 	1,600	360	Level 5	Medium
<p>Option 3:</p> <ul style="list-style-type: none"> 140 km single-circuit 330 kV from Bulli Creek-Millmerran-Middle Ridge. 330/275 kV transformer at Middle Ridge with associated shunt capacitor. Special Protection scheme involving 300 MW SEQ BESS and generation runback within Q8 REZ. 	1,900	365 + BESS costs to be provided by interested parties	Level 5	Medium
Adjustment factors and risk				
Option	Adjustment factors applied	Known and unknown risks applied		
Option 1	<ul style="list-style-type: none"> Location: Regional 	<ul style="list-style-type: none"> Known risks: Outage restrictions 'High' Unknown risks: Class 5 		
Option 2	<ul style="list-style-type: none"> Circuit terrain: Hilly/undulating 	<ul style="list-style-type: none"> Known risks: Outage restrictions 'High' 		

	<ul style="list-style-type: none"> • Total Circuit length: < 200 km • Location: Regional 	<ul style="list-style-type: none"> • Unknown risks: Class 5
Option 3	<ul style="list-style-type: none"> • Circuit terrain: Hilly/undulating • Total Circuit length: < 200 km • Location: Regional 	<ul style="list-style-type: none"> • Known risks: • Outage restrictions: High • Project complexity: Partly complex • Unknown risks: Class 5

4.3.9 Banana (Q9)

Summary				
<p>The Banana REZ is located roughly 200 km south-west of Gladstone and lies north of the CQ-SQ flow path (see Section 3.4). It has moderate wind and excellent solar resources. There are currently no generators and very little high voltage network in this area.</p> <p>The first two options are proposals that transport the power to the Gladstone region. Substation location both within the Banana REZ and the connection point within the Gladstone section will be based on where generation and load develop.</p>				
Existing network capability				
<p>There is very little high voltage network in the area currently. There is some low capacity 132 kV network on the edge of the REZ to support the townships of Moura and Biloela.</p> <p>There is very little spare capacity within the current network which doesn't extend very far into the REZ. There is no easy way to reach the high voltage network or the Gladstone load.</p> <p>Output from this REZ for options 1 and 2 will also be included in the NQ3 group constraint augmentations that facilitate power from Q1 to Q6 to be transmitted south to the load centres (see Section 4.3.10 (NQ3)).</p>				
Augmentation options				
Description	Additional network capacity (MW)	Expected cost (\$ million)	Cost classification	Lead time
<p>Option 1: 500 kV option</p> <ul style="list-style-type: none"> Establish a new 500 kV substation within the Banana REZ. Establish a new 500 kV substation near Gladstone. 200 km double-circuit 500 kV line from the Banana REZ to Gladstone. Three 500/275 kV 1,500 MVA transformers near Gladstone. Switchgear at the existing Gladstone substation. Connection from Gladstone to the new Gladstone substation. <p>Note: This option is used as the generic REZ augmentation to connect REZs to hydrogen export ports†. This is expressed as a \$/MW/km to suit different distances. Using Option 1 this generic cost works out at \$1,608/MW/km.</p>	3,000	965	Class 5 (±30%)	Long
<p>Option 2: 275 kV option</p> <ul style="list-style-type: none"> Establish a new 275 kV substation within the Banana REZ. 200 km double-circuit 275 kV line from Banana REZ to Gladstone. Switchgear at Gladstone. 	1,000	495	Class 5 (±30%)	Long

<p>Option 3: 275 kV option to Wandoan South</p> <ul style="list-style-type: none"> • Establish a new 275 kV substation within the Banana REZ. • 195 km double-circuit 275 kV line from Banana REZ to Wandoan South. • Switchgear at Wandoan South. 	1,000	480	Class 5 (±30%)	Long
Adjustment factors and risk				
Option	Adjustment factors applied		Known and unknown risks applied	
Option 1	<ul style="list-style-type: none"> • Estimated 25% proportion of project in environmentally sensitive areas • 'Remote' location for Banana REZ Substation • Total circuit length 'above 200 km', in non-cyclone region (south of Bouldercombe). 		<ul style="list-style-type: none"> • Known risks: Project Complexity was judged as partly complex due to no 500 kV network yet built in the Queensland region • Unknown risks: Class 5 	
Option 2	<ul style="list-style-type: none"> • Estimated 25% proportion of project in environmentally sensitive areas • 'Remote' location for Banana REZ Substation • Total circuit length 'above 200 km', in non-cyclone region (south of Bouldercombe). 		<ul style="list-style-type: none"> • Known risks: BAU • Unknown risks: Class 5 	
Option 3	<ul style="list-style-type: none"> • Estimated 25% proportion of project in environmentally sensitive areas • 'Remote' location for Banana REZ Substation • 'Brownfield' work for Wandoan South connection • Total circuit length '100 – 200km', in non-cyclone region (south of Bouldercombe). 		<ul style="list-style-type: none"> • Known risks: BAU • Unknown risks: Class 5 	

† The assumptions relating to REZ expansions for hydrogen export are described in the Draft IASR. See section 4.14 of Draft Input, Assumptions and Scenarios report, at https://www.aemo.com.au/-/media/files/electricity/nem/planning_and_forecasting/inputs-assumptions-methodologies/2021/draft-2021-inputs-assumptions-and-scenarios-report.pdf?la=en.

4.3.10 Queensland Group Constraints

Due to the long, unmeshed nature of the Queensland network, group constraints are the augmentations that are required to facilitate the transmission of power from isolated REZs (mostly in northern Queensland) to load centres in the south. They are not directly linked with the builds of a specific REZ, but rather the augmentations needed further into the network that are required due to the combined output from a number of REZs.

NQ1 Facilitating power out of North Queensland

Summary				
<p>The Group Constraint NQ1 can be built when generation in Q1 + Q2 + Q3 (North Queensland) exceed 1,200 MW. This augmentation facilitates transmission from North Queensland to load centres in Central and Southern Queensland.</p>				
Existing network capability				
<p>The current network was designed to facilitate the transmission of power from Central Queensland to supply load in Northern Queensland. The network has the ability to support up to 1,200 MW of generation across the three REZs in North Queensland depending also on the level of storage in these REZs.</p>				
Augmentation options				
Description	Additional network capacity (MW)	Expected cost (\$ million)	Cost classification	Lead time
Option 1: <ul style="list-style-type: none"> Uprate the lower rated section of the 275 kV Ross – Strathmore circuits to a higher capacity. 	300	15†	Class 5 (±30%)	Short
Option 2: <ul style="list-style-type: none"> Construct an additional circuit from Ross to Strathmore to Nebo. 	1,000	710	Class 5 (±30%)	Medium
Adjustment factors and risk				
Option	Adjustment factors applied	Known and unknown risks applied		
Option 1	<ul style="list-style-type: none"> Provided by Powerlink 	<ul style="list-style-type: none"> Provided by Powerlink 		
Option 2	<ul style="list-style-type: none"> Estimated 25% proportion of project in environmentally sensitive areas 'Regional' location chosen Total circuit length 'above 200 km', in cyclone region. 	<ul style="list-style-type: none"> Known risks: BAU Unknown risks: Class 5 		

† Cost based on estimate provided by Powerlink for 2020 ISP.

NQ2 Facilitating power to Central Queensland

Summary				
<p>The Group Constraint NQ2 can be built when generation in Q1 to Q5 (Northern Queensland) exceeds 2,500 MW. This is in order to facilitate transmission of this generation to load centres in the south.</p> <p>Two options are proposed that transport the power and both involve the Nebo – Bouldercombe lines.</p> <p>This group constraint is associated with the CQ-NQ intraregional connection.</p>				
Existing network capability				
<p>The current network was designed to facilitate the transmission of power from Central Queensland to support the load in Northern Queensland. Thus, its capacity was designed around North Queensland load, rather than building for future generation projects. As such, the network has the ability to support up to 2,500 MW of generation across the five REZs in Northern Queensland depending also on the level of storage in these REZs.</p>				
Augmentation options				
Description	Additional network capacity (MW)	Expected cost (\$ million)	Cost classification	Lead time
Option 1: <ul style="list-style-type: none"> Power Flow Controller device on Nebo – Bouldercombe 275 kV line to increase/decrease the impedance of the Nebo – Bouldercombe 275 kV circuit. 	300	30	Class 5 (±30%)	Medium
Option 2: <ul style="list-style-type: none"> Construct a second 275 kV circuit from Nebo – Bouldercombe. 	900	630	Class 5 (±30%)	Long
Adjustment factors and risk				
Option	Adjustment factors applied	Known and unknown risks applied		
Option 1	<ul style="list-style-type: none"> Estimated 25% proportion of project in environmentally sensitive areas 'Regional' location chosen 	<ul style="list-style-type: none"> Known risks: Project Complexity was judged as partly complex as PFC are devices not currently utilised in the Queensland transmission network. Unknown risks: Class 5 		
Option 2	<ul style="list-style-type: none"> Estimated 25% proportion of project in environmentally sensitive areas 'Regional' location chosen Total circuit length 'above 200 km', in cyclone region. 	<ul style="list-style-type: none"> Known risks: BAU Unknown risks: Class 5 		

NQ3 Facilitating power to Southern Queensland

Summary				
<p>The Group Constraint NQ3 can be built to facilitate export of over 2,100 MW of generation from Central and Northern Queensland to Southern Queensland.</p> <p>The existing limit is defined by the transient stability level rather than a thermal limit as the associated circuits are long (over 300 km).</p> <p>This group constraint is associated with the CQ-SQ intraregional constraint, and takes into account the output from Q1-Q6, as well as Q9.</p>				
Existing network capability				
<p>The current network was designed to facilitate the transmission of power from Central Queensland to support the load in Southern Queensland. The network has the ability to support up to 2,100 MW of power transfer from Central Queensland to Southern Queensland which is defined as the transient stability limit of the network prior to a contingency of Calvale-Halys 275 kV circuit.</p>				
Augmentation options				
Description	Additional network capacity (MW)	Expected cost (\$ million)	Cost classification	Lead time
<p>Option 1:</p> <ul style="list-style-type: none"> Construct a 275 kV double-circuit line from Calvale – Wandoan South. 	To be provided by Powerlink	To be provided by Powerlink	To be provided by Powerlink	To be provided by Powerlink
<p>Option 2:</p> <ul style="list-style-type: none"> Mid-point switching substation on the Calvale – Halys 275 kV double-circuit line. 	300	50	Class 5 (±30%)	Short
<p>Option 3:</p> <ul style="list-style-type: none"> Non-network option - A Virtual Transmission Line option with a 300 MW energy storage system in north of Calvale and South of Halys. 	300	To be provided by interested parties	N/A	To be provided by interested parties
<p>Option 4:</p> <ul style="list-style-type: none"> 2,000 MVA bipole HVDC and overhead line between Calvale and Wandoan South 	1,750	1,630	Class 5 (±30%)	Long
Adjustment factors and risk				
Option	Adjustment factors applied	Known and unknown risks applied		
Option 1	<ul style="list-style-type: none"> N/A - To be provided by Powerlink 	<ul style="list-style-type: none"> N/A - To be provided by Powerlink 		
Option 2	<ul style="list-style-type: none"> Location: Regional Land use: Scrub Proportion of environmentally sensitive areas: 25% Delivery timetable Optimum Project size: 1-5 bays 	<ul style="list-style-type: none"> Known risks: BAU Unknown risks: Class 5 Outage restrictions: High 		
Option 3	<ul style="list-style-type: none"> To be provided by interested parties 	<ul style="list-style-type: none"> To be provided by interested parties 		

Option 4	<ul style="list-style-type: none"> • Location: Remote • Land use: Grazing • Project size: applicable for HVDC converter station 	<ul style="list-style-type: none"> • Delivery timetable: Long • Total circuit length: above 200 km • Proportion of environmentally sensitive areas: 25% 	<ul style="list-style-type: none"> • Known risks: BAU • Unknown risks: Class 5 	<ul style="list-style-type: none"> • Project complexity: Highly complex
----------	--	--	--	--

4.4 South Australia

4.4.1 South East SA (S1)

Summary				
<p>The South East South Australia REZ lies on the major 275 kV route of the South Australia-Victoria Heywood interconnector. The REZ has moderate to good quality wind resources as it evidenced by the high proportion of wind generation (over 300 MW) in near the South East border with Victoria.</p>				
Existing network capability				
<p>There is currently no existing network hosting capacity available in this REZ without further augmentation. Network augmentations would be smaller if generation is located relatively close to Adelaide, and larger if located further south towards Mount Gambier.</p>				
Augmentation options				
Description	Additional network capacity (MW)	Expected cost (\$ million)	Cost classification	Lead time
<p>Option 1:</p> <ul style="list-style-type: none"> • String vacant circuit on the 275 kV Tungkillo – Tailem Bend line. • Turn in 275 kV circuit Tailem Bend to Cherry Gardens at Tungkillo†. • 100 MVar SVC at Tailem Bend 	800	60	Class 5 (±30%)	Medium
<p>Option 2:</p> <ul style="list-style-type: none"> • 500 kV double-circuit line connecting South East to Heywood. 	2,000	440	Class 5 (±30%)	Long
Adjustment factors and risk				
Option	Adjustment factors applied	Known and unknown risks applied		
Option 1	<ul style="list-style-type: none"> • Delivery timetable: Medium • Land use: Grazing • Project network element size: 10 to 100 km, no. of bays 1-5 • Proportion of environmentally sensitive areas: 0% • Location (regional/distance factors): Regional 	<ul style="list-style-type: none"> • Known Risks: BAU. No offset for Compulsory acquisition, Cultural heritage, Environmental offset risks, Geotechnical findings as not relevant to overall project scope • Unknown risks: Class 5 		
Option 2	<ul style="list-style-type: none"> • Delivery timetable: Long • Land use: Grazing • Project network element size: 10 to 100 km, no. of bays 1-5 • Proportion of environmentally sensitive areas: 0% • Location (regional/distance factors): Regional 	<ul style="list-style-type: none"> • Known risks: BAU, Outage restrictions: High • Unknown risks: Class 5 		

† This upgrade component is also flagged as a potential Network Capability Incentive Parameter Action Plan (NCIPAP) upgrade by ElectraNet.

4.4.2 Riverland (S2)

Summary				
<p>The Riverland REZ is on the South Australian side of the proposed Project EnergyConnect route. It has good solar quality resources.</p>				
Existing network capability				
<p>There is minimal existing renewable generation in the zone. Prior to Project EnergyConnect, approximately 200 MW can be connected in this REZ. Once Project EnergyConnect is commissioned (2024-25), approximately 800 MW can be accommodated.</p> <p>Additional generation beyond 1,000 MW is not practical without extensive further network upgrades between Riverland and South Australia's neighbouring states.</p>				
Augmentation options				
Description	Additional network capacity (MW)	Expected cost (\$ million)	Cost classification	Lead time
<p>Option 1 (Post PEC):</p> <ul style="list-style-type: none"> • Turn Bunday – Buronga 330 kV No. 1 and No. 2 lines into a new substation at Riverland. 	800	60	Class 5 (±30%)	Medium
<p>Option 2 (Prior to PEC):</p> <ul style="list-style-type: none"> • 330 kV double-circuit Riverland-Robertstown. • 330 kV double-circuit Buronga-Riverland. • 330/132 kV transformation at Riverland. • 330/275 kV transformation at Robertstown. • 330/220 kV transformation at Buronga. 	800	880	Class 5 (±30%)	Long
Adjustment factors and risk				
Option	Adjustment factors applied	Known and unknown risks applied		
Option 1	<ul style="list-style-type: none"> • Delivery timetable: Long • Land use: Grazing • Project network element size: 10 to 100 km, no. of bays 6-10 • Proportion of environmentally sensitive areas: 0% • Location (regional/distance factors): Remote 	<ul style="list-style-type: none"> • Known risks: BAU, Outage restrictions: High • Unknown risks: Class 5 		
Option 2	<ul style="list-style-type: none"> • Delivery timetable: Long • Land use: Grazing • Project network element size: Above 200 km, no. of bays 26-30 • Proportion of environmentally sensitive areas: 0% • Location (regional/distance factors): Remote 	<ul style="list-style-type: none"> • Known risks: BAU, Outage restrictions: High • Unknown risks: Class 5 		

4.4.3 Mid-North SA (S3)

Summary				
<p>The Mid-North SA REZ has moderate quality wind and solar resources. There are several major wind farms in service in this REZ, totalling > 950 MW installed capacity.</p> <p>Four 275 kV parallel circuits provide the bulk transmission along the corridor from Davenport to near Adelaide (Para) which traverse this REZ. This transmission corridor forms the backbone for exporting power from REZs north and west of this REZ in South Australia.</p>				
Existing network capability				
<p>This REZ can accommodate approximately 1,000 MW of additional generation along the 275 kV corridor. However, due to the network configuration, any generation north and west of this REZ also contributes to this 1,000 MW limit. For this reason, an aggregate limit for South Australia of 1,000 MW applies to S3, S4, S5, S6, S7, S8 and S9 (see MN1 Group Constraint in Section 4.4.10).</p>				
Augmentation options				
Description	Additional network capacity (MW)	Expected cost (\$ million)	Cost classification	Lead time
Option 1 <ul style="list-style-type: none"> 275 kV double-circuit lines between Robertstown, Templers West and Para. 	1,000 [†]	270	Class 5 (±30%)	Long
Option 2 <ul style="list-style-type: none"> 275 kV double-circuit lines between Davenport and Robertstown. 	1,000	540	Class 5 (±30%)	Long
Adjustment factors and risk				
Option	Adjustment factors applied	Known and unknown risks applied		
Option 1	<ul style="list-style-type: none"> Delivery timetable: Long Land use: Grazing Project network element size: 10-100 km, no. of bays 11-15 Proportion of environmentally sensitive areas: 0% Location (regional/distance factors): Regional Terrain: Flat/farmland (except Para to Templers West which is Hilly/undulating) 	<ul style="list-style-type: none"> Known risks: BAU Unknown risks: Class 5 		
Option 2	<ul style="list-style-type: none"> Delivery timetable: Long Land use: Grazing Project network element size: Above 200 km, no. of bays 1-5 Proportion of environmentally sensitive areas: 0% Location (regional/distance factors): Remote Terrain: Flat/farmland 	<ul style="list-style-type: none"> Known risks: BAU Unknown risks: Class 5 		

[†] Additional network hosting capacity is South of Robertstown towards Adelaide. This option does not alleviate the MN1_SA group constraint.

4.4.4 Yorke Peninsula (S4)

Summary				
<p>The Yorke Peninsula REZ has good quality wind resources.</p> <p>A single 132 kV line extends from Hummocks to Wattle Point (towards the end of Yorke Peninsula).</p>				
Existing network capability				
<p>The existing 132 kV network has no additional network capacity. Transmission augmentation is required to connect any significant additional generation in this REZ.</p> <p>S4 is part of the MN1 Group Constraint† (see Section 4.4.10).</p>				
Augmentation options				
Description	Additional network capacity (MW)	Expected cost (\$ million)	Cost classification	Lead time
<p>Option 1 (Stage 1):</p> <ul style="list-style-type: none"> String first circuit of a 275 kV double-circuit line from Blythe West into new Yorke Peninsula substation. 	250‡	330	Class 5 (±30%)	Long
<p>Option 2: (Stage 2)</p> <ul style="list-style-type: none"> String second circuit of a 275 kV double-circuit line from Blythe West into new Yorke Peninsula substation. <p>Pre-requisite: Stage 1</p>	1,000	80	Class 5 (±30%)	Medium
Adjustment factors and risk				
Option	Adjustment factors applied	Known and unknown risks applied		
Option 1 and 2	<ul style="list-style-type: none"> Delivery timetable: Long Land use: Grazing Project network element size: 100 - 200 km, no. of bays 6-10 Proportion of environmentally sensitive areas: 0% Location (regional/distance factors): Remote Terrain: Flat/Farmland 	<ul style="list-style-type: none"> Known risks: BAU Unknown risks: Class 5 		

† Additional augmentation is required in Mid-North when the combination of generation in S3, S4, S5, S6, S7, S8, S9 >1,000 MW.

‡ A 250 MW limit is set for single-circuit radial REZs in South Australia to limit the loss of generation following a credible contingency.

4.4.5 Northern SA (S5)

Summary				
<p>The Northern SA REZ has good solar and moderate wind resources. This REZ forms a candidate for a hydrogen electrolyser facility in South Australia.</p>				
Existing network capability				
<p>The capability of this zone to accommodate new generation is subject to the MN1-SA Mid-North group constraints. The build limit is set by this limitation at 1,000 MW†.</p>				
Augmentation options				
Description	Additional network capacity (MW)	Expected cost (\$ million)	Cost classification	Lead time
<ul style="list-style-type: none"> Option 1: Uprate the existing 275 kV Davenport – Cultana lines with replacement CTs, isolators, circuit breakers, line droppers, line droppers and lifting of 5 spans. 	200	10	Class 5 (±30%)	Short
<ul style="list-style-type: none"> Option 2: 275 kV double-circuit line, single side strung, from Davenport – Cultana. 	600	150	Class 5 (±30%)	Long
<ul style="list-style-type: none"> Option 3: String second 275 kV single-circuit from Davenport – Cultana. Requires option 2 already built. 	1,200	40	Class 5 (±30%)	Long
Adjustment factors and risk				
Option	Adjustment factors applied	Known and unknown risks applied		
Option 1	<ul style="list-style-type: none"> Delivery timetable: Long Land use: Grazing Project network element size: 10-100 km, no. of bays 6-10 Proportion of environmentally sensitive areas: 0% Location (regional/distance factors): Remote 	<ul style="list-style-type: none"> Known risks: BAU, cost does not include line re-spanning works. Unknown risks: Class 5 		
Option 2 and Option 3	<ul style="list-style-type: none"> Delivery timetable: Long Land use: Grazing Project network element size: 10-100 km, no. of bays 6-10 Proportion of environmentally sensitive areas: 0% Location (regional/distance factors): Remote 	<ul style="list-style-type: none"> Known risks: BAU Unknown risks: Class 5 		

† Additional augmentation is required in Mid-North when the combination of generation in S3, S4, S5, S6, S7, S8, S9 >1,000 MW.

4.4.6 Leigh Creek (S6)

Summary				
<p>The Leigh Creek REZ is located between 150 and 350 km north-east of Davenport. It has excellent solar resources and good wind resources.</p> <p>This REZ is currently supplied with a single 132 kV line.</p>		<p>The map displays a transmission line route starting from Davenport and extending northeast to a green oval representing the Leigh Creek REZ. The route is labeled 'Option 1,2'.</p>		
Existing network capability				
<p>There is no additional hosting capacity within this REZ.</p> <p>The capability of this zone to accommodate new generation is subject to the MN1-SA Mid-North group constraints (see Section 4.4.10). The build limit is set by this limitation at 1,000 MW†.</p>				
Augmentation options				
Description	Additional network capacity (MW)	Expected cost (\$ million)	Cost classification	Lead time
<p>Option 1: (Stage 1)</p> <ul style="list-style-type: none"> • 275 kV double-circuit line, single side strung from Davenport to new Leigh Creek substation. 	250‡	490	Class 5 (±30%)	Long
<p>Option 2: (Stage 2)</p> <ul style="list-style-type: none"> • String second 275 kV circuit from Davenport to new Leigh Creek substation. <p>Pre-requisite: Stage 1</p>	1,000	170	Class 5 (±30%)	Long
Adjustment factors and risk				
Option	Adjustment factors applied	Known and unknown risks applied		
Options 1 and 2	<ul style="list-style-type: none"> • Delivery timetable: Long • Land use: Scrub (except Davenport substation which is Grazing) • Project network element size: Above 200 km, no. of bays 1-5 • Proportion of environmentally sensitive areas: 0% • Location (regional/distance factors): Remote • Terrain: Flat/Farmland 	<ul style="list-style-type: none"> • Known risks: BAU • Unknown risks: Class 5 		

† Additional augmentation is required in Mid-North when the combination of generation in S3, S4, S5, S6, S7, S8, S9 >1,000 MW.

‡ A 250 MW limit is set for single-circuit radial REZs in South Australia to limit the loss of generation following a credible contingency.

4.4.7 Roxby Downs (S7)

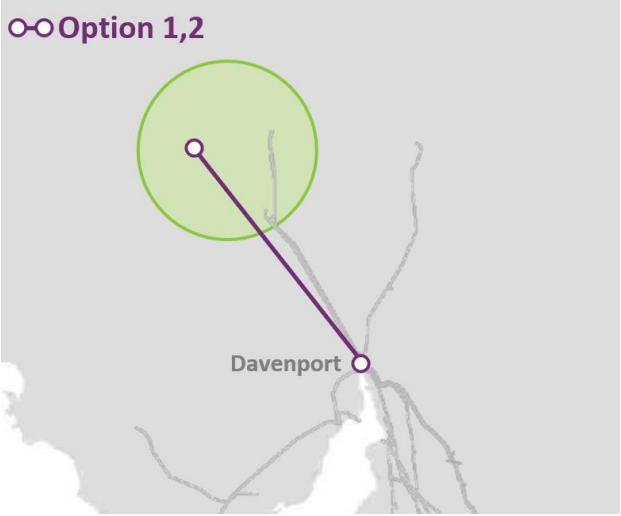
Summary				
<p>The Roxby Downs REZ is located a few hundred kilometres north west of Davenport. It has excellent solar resources. The only significant load in the area is the Olympic Dam and Carrapateena mines.</p> <p>This REZ is currently connected with a 132 kV line and privately owned 275 kV line from Davenport. ElectraNet has recently extended the 275 kV system to develop a new 275/132 kV connection point at Mount Gunson South to service OZ Minerals' new and existing mines in the area. This new 275 kV line replaces the old 132 kV Davenport to Mt Gunson South line which has been decommissioned.</p>				
Existing network capability				
<p>The existing network hosting capacity of this REZ is 960 MW, although the capability of this zone to accommodate new generation is subject to the MN1-SA Mid-North group constraints. The build limit is set by this limitation at 1,000 MW†.</p>				
Augmentation options				
Description	Additional network capacity (MW)	Expected cost (\$ million)	Cost classification	Lead time
Option 1: (Stage 1) <ul style="list-style-type: none"> • 275 kV double-circuit single side strung from Davenport to new Roxby Downs substation. 	250‡	540	Class 5 (±30%)	Long
Option 2: (Stage 2) <ul style="list-style-type: none"> • String second 275 kV circuit line from Davenport to new Roxby Downs substation. Pre-requisite: Stage 1	1,000	180	Class 5 (±30%)	Long
Adjustment factors and risk				
Option	Adjustment factors applied	Known and unknown risks applied		
Option 1	<ul style="list-style-type: none"> • Delivery timetable: Long • Land use: Scrub (except Davenport substation which is Grazing) • Project network element size: Above 200 km, no. of bays 1-5 • Proportion of environmentally sensitive areas: 0% • Location (regional/distance factors): Remote 	<ul style="list-style-type: none"> • Known risks: BAU • Unknown risks: Class 5 		

† Additional augmentation is required in Mid-North when the combination of generation in S3, S4, S5, S6, S7, S8, S9 >1,000 MW.

‡ A 250 MW limit is set for single-circuit radial REZs in South Australia to limit the loss of generation following a credible contingency.

4.4.8 Eastern Eyre Peninsula (S8)

Summary				
<p>The Eastern Eyre Peninsula REZ has moderate to good quality wind resources.</p> <p>The Eyre Peninsula Link RIT-T is a committed project in which the existing Cultana–Yadnarie–Port Lincoln 132 kV single-circuit line will be replaced with a new double-circuit 132 kV line. The section between Cultana to Yadnarie will be built to operate at 275 kV, however it will be energised at 132 kV upon commissioning. This project is due to be replaced in December 2022.</p>		<p>The map shows the Eastern Eyre Peninsula region in South Australia. A green shaded area represents the REZ. A purple line with two circles at its ends, labeled 'Option 1', indicates a transmission route starting from Port Lincoln and heading east towards Adelaide. The city of Adelaide is marked with a black dot.</p>		
Existing network capability				
<p>The existing network capacity of this REZ is 470 MW. Although the capability of this zone to accommodate new generation is subject to the MN1-SA Mid-North group constraints. The build limit is set by this limitation at 1,000 MW†. An additional Group Constraint is under consideration that will take into account the combined capacities of S8 and S9 on the network limitations in S5.</p>				
Augmentation options				
Description	Additional network capacity (MW)	Expected cost (\$ million)	Cost classification	Lead time
<p>Option 1:</p> <ul style="list-style-type: none"> Operate the future Cultana–Yadnarie 132 kV double-circuit line (built as part of the Eyre Peninsula Link RIT-T) at 275 kV by establishing a 275 kV substation at Yadnarie. 	300	50‡	Class 5 (±30%)	Medium
Adjustment factors and risk				
Option	Adjustment factors applied	Known and unknown risks applied		
Option 1	<ul style="list-style-type: none"> Provided by ElectraNet 	<ul style="list-style-type: none"> Provided by ElectraNet 		

† Additional augmentation is required in Mid-North when the combination of generation in S3, S4, S5, S6, S7, S8, S9 >1,000 MW.

‡ ElectraNet TAPR cost used as scope of works for operating circuits at higher voltage levels not well defined within the current Transmission Cost Database.

4.4.9 Western Eyre Peninsula (S9)

Summary				
<p>The Western Eyre Peninsula REZ shares the same electrical network as the Eastern Eyre Peninsula. It has good solar and moderate wind resources. There are no generators currently connected or committed within this REZ.</p>				
Existing network capability				
<p>There is no additional hosting capacity within this REZ.</p> <p>The capability of this zone to accommodate new generation is subject to the MN1-SA Mid-North group constraints. The build limit is set by this limitation at 1,000 MW†.</p> <p>An additional Group Constraint is under consideration that will take into account the combined capacities of S8 and S9 on the network limitations in S5.</p>				
Augmentation options				
Description	Additional network capacity (MW)	Expected cost (\$ million)	Cost classification	Lead time
<p>Option 1:</p> <ul style="list-style-type: none"> 275 kV double-circuit line from Cultana/Corraberra Hill to a new Elliston substation. 	1,050	620	Class 5 (±30%)	Long
<p>Option 2:</p> <ul style="list-style-type: none"> 275 kV single-circuit line from Yadnarie to a new Elliston substation. 	300-500	330	Class 5 (±30%)	Long
<p>Option 3:</p> <ul style="list-style-type: none"> New Elliston substation. Single-circuit 275 kV line from Cultana/Corraberra Hill to Elliston. Single-circuit 275 kV line from Yadnarie to Elliston. 	1,200	820	Class 5 (±30%)	Long
Adjustment factors and risk				
Option	Adjustment factors applied	Known and unknown risks applied		
Options 1, 2 and 3	<ul style="list-style-type: none"> Delivery timetable: Long Land use: Grazing Project network element size: Above 200 km (Cultana-Elliston), 100-200 km (Yadnarie to Elliston), no. of bays 6-10 Proportion of environmentally sensitive areas: 0% Location (regional/distance factors): Remote 	<ul style="list-style-type: none"> Known risks: BAU Unknown risks: Class 5 		

† Additional augmentation is required in Mid-North when the combination of generation in S3, S4, S5, S6, S7, S8, S9 >1,000 MW.

4.4.10 SA Group constraints

MN1_SA

Summary				
<p>The Group Constraint MN1_SA represents the generation build limit applied to S3, S4, S5, S6, S7, S8, S9 REZs. This constraint is necessary because these REZs all must export any additional power generation south towards Adelaide primarily along the existing four 275 kV parallel circuits from Davenport to near Adelaide (Para). This corridor of the network thus forms a bottleneck for these REZs.</p> <p>The application of this group constraint in relation to Hydrogen modelling will be reviewed in order to take into account the potential load associated with an Eyre Peninsula or Northern SA Hydrogen Hub.</p>				
Existing network capability				
<p>The individual REZs which form this group constraint each have their own individual existing network capabilities. The collective generation build from S3 to S9 cannot exceed 1,000 MW without additional network augmentation between Davenport and Adelaide.</p>				
Augmentation options				
Description	Additional network capacity (MW)	Expected cost (\$ million)	Cost classification	Lead time
<p>Augmentation to alleviate the MN1_SA group constraint is linked to the S3 Mid-North REZ development. Either Option 1 or Option 2 are required to increase the transfer capacity of this group constraint.</p>				
<p>Option 1:</p> <ul style="list-style-type: none"> 275 kV double-circuit lines between Robertstown, Templers West and Para. 	1,000	270	Class 5 (±30%)	Long
<p>Option 2:</p> <ul style="list-style-type: none"> 275 kV double-circuit lines between Davenport and Robertstown. 		540	Class 5 (±30%)	Long
Adjustment factors and risk				
Option	Adjustment factors applied	Known and unknown risks applied		
Option 1	<ul style="list-style-type: none"> Delivery timetable: Long Land use: Grazing Project network element size: 10-100 km, no. of bays 11-15 Proportion of environmentally sensitive areas: 0% Location (regional/distance factors): Regional Terrain: Flat/farmland (except Para to Templers West which is Hilly/undulating) 	<ul style="list-style-type: none"> Known risks: BAU Unknown risks: Class 5 		
Option 2	<ul style="list-style-type: none"> Delivery timetable: Long Land use: Grazing Project network element size: Above 200 km, no. of bays 1-5 Proportion of environmentally sensitive areas: 0% Location (regional/distance factors): Remote Terrain: Flat/farmland 	<ul style="list-style-type: none"> Known risks: BAU Unknown risks: Class 5 		

4.5 Tasmania

4.5.1 North East Tasmania (T1)

Summary				
<p>This REZ has a good quality wind resources and moderate solar resources. North East Tasmania is distanced from the proposed Marinus Link augmentations and therefore upgrades are less influenced by the proposed new interconnector (see Section 3.10).</p>		<p>○-○ Option 1 ○-○ Option 2</p>		
Existing network capability				
<p>Currently there is no capacity on the 110 kV network from Hadspen to Derby. There is approximately 400 MW of network capacity available at George Town.</p>				
Augmentation options				
Description	Additional network capacity (MW)	Expected cost (\$ million)	Cost classification	Lead time
<p>Option 1:</p> <ul style="list-style-type: none"> 80 km 220 kV double-circuit line between George Town and a new substation in north-east Tasmania, strung on one side. 	144 [†]	181	Class 5 (±30%)	Long
<p>Option 2:</p> <ul style="list-style-type: none"> String other side of 220 kV transmission line between George Town and the north-east Tasmania substation. <p><i>Pre-requisite: Option 1</i></p>	650	51	Class 5 (±30%)	Medium
Adjustment factors and risk				
Option	Adjustment factors applied	Known and unknown risks applied		
Option 1	<ul style="list-style-type: none"> Land use: Grazing Project network element size: 10 to 100 km, no. of bays 1-5 Proportion of environmentally sensitive areas: 25% Location (regional/distance factors): Regional Delivery Timetable: Long 	<ul style="list-style-type: none"> Known risks: BAU Unknown risks: Class 5 		
Option 2	<ul style="list-style-type: none"> Land use: Grazing Project network element size: 10 to 100 km Proportion of environmentally sensitive areas: 25% Location (regional/distance factors): Remote 	<ul style="list-style-type: none"> Known risks: BAU Unknown risks: Class 5 		

[†] Reduced from maximum rating of the transmission line to ensure loss of generation following a credible contingency does not cause system security issues.

4.5.2 North West Tasmania (T2)

Summary				
<p>This REZ has high quality wind resources. The North West Tasmania augmentation options are highly dependent on Marinus Link (see Section 3.10), with some REZ augmentations already included in the proposed Marinus Link AC augmentations.</p>		<p>Queenstown ● Launceston ● Hobart ●</p> <p>○-○ Option 1 ○-○ Option 2</p>		
Existing network capability				
<p>The current network hosting capacity before upgrade in North West Tasmania is approximately 340 MW. Future REZ generators are assumed to have a runback scheme in place post contingency to reduce generation output within network capacity.</p>				
Augmentation options				
Description	Additional network capacity (MW)	Expected cost (\$ million)†	Cost classification	Lead time
<p>Option 1:</p> <ul style="list-style-type: none"> Rebuild Burnie-Sheffield 220 kV line as a double-circuit line (note this is part of Marinus Link Stage 1 augmentations and therefore two expected costs have been provided – one excluding this transmission line and the other including it). Build a double-circuit 220 kV transmission line from Hampshire to the Burnie area (note this is part of the Marinus Link Stage 2 augmentations). 	900	100 (with Marinus Link) 250 (without Marinus Link)	Class 5 (±30%)	Long
<p>Option 2:</p> <ul style="list-style-type: none"> Build double-circuit Burnie-West Montague 220 kV line Rebuild the Burnie-Marinus Link converter station 220 kV transmission line as a double-circuit (note this is a part of the Marinus Link Stage 2 augmentations). <p><i>Pre-requisite: Option 1</i></p>	900	280 (with Marinus Link) 330 (without Marinus Link)	Class 5 (±30%)	Long
Adjustment factors and risk				
Option	Adjustment factors applied	Known and unknown risks applied		
Option 1	<ul style="list-style-type: none"> Greenfield or Brownfield: Brownfield Location (regional/distance factors): Regional Project network element size: no. of total Bays 1-5, 10 to 100 km Terrain: Mountainous Delivery Timetable: Long 	<ul style="list-style-type: none"> Known risks: BAU Unknown risks: Class 5 		
Option 2	<ul style="list-style-type: none"> Greenfield or Brownfield: Brownfield Location (regional/distance factors): Regional Project network element size: no. of total Bays 1-5, 10 to 100 km Terrain: Mountainous Delivery Timetable: Long 	<ul style="list-style-type: none"> Known risks: BAU Unknown risks: Class 5 		

† AEMO Transmission Cost Database estimates shown. Will be updated with Marinus Link RIT-T estimates if available.

4.5.3 Central Highlands (T3)

Summary				
<p>This REZ has one of the best wind resources in the NEM and has good pumped hydro resources. It is located close to major load centres at Hobart. The Tasmania Central Highlands augmentation options are influenced by the Marinus Link augmentations.</p>				
Existing network capability				
<p>The current network hosting capacity before upgrade in the Central Highlands is approximately 480 MW across Liapootah, Waddamana and Palmerston.</p>				
Augmentation options				
Description	Additional network capacity (MW)	Expected cost (\$ million)†	Cost classification	Lead time
<p>Option 1:</p> <ul style="list-style-type: none"> • If before Marinus Link 1, bring forward the rebuild of Palmerston-Sheffield 220 kV line as double-circuit and build 2 x power flow controllers on the 2 x 220 kV transmission lines from Palmerston-Hadspen. • If after Marinus Link 1, build 2 x power flow controllers on the 2 x 220 kV transmission lines from Palmerston-Hadspen. 	620	50 (with Marinus Link) 280 (without Marinus Link)	Class 5 (±30%)	Long
<p>Option 2:</p> <ul style="list-style-type: none"> • Build a Sheffield-Palmerston-Waddamana 220 kV line strung on one side. <p>Pre-requisite: Option 1 and Marinus Link (Stage 1)</p>	450	300	Class 5 (±30%)	Long
<p>Option 3:</p> <ul style="list-style-type: none"> • Build an additional Marinus Link-Sheffield 220 kV line. <p>Pre-requisites: Options 1 and 2 and Marinus Link stage 2.</p>	250	90	Class 5 (±30%)	Long
<p>Option 4:</p> <ul style="list-style-type: none"> • String other side of Sheffield-Palmerston-Waddamana 220 kV line. <p>Pre-requisite: Options 1, 2 and 3 and Marinus Link stage 2.</p>	500	100	Class 5 (±30%)	Medium
<p>Option 5:</p> <ul style="list-style-type: none"> • Build a fifth Sheffield-Palmerston 220 kV line. <p>Pre-requisite: Options 1, 2, 3 and 4 and Marinus Link stage 2.</p>	500	160	Class 5 (±30%)	Long
Adjustment factors and risk				
Option	Adjustment factors applied	Known and unknown risks applied		
Option 1	<ul style="list-style-type: none"> • Greenfield or Brownfield: Brownfield 	<ul style="list-style-type: none"> • Known risks: BAU 		

	<ul style="list-style-type: none"> • Location (regional/distance factors): Regional • Project network element size: no. of Bays 1-5 • Delivery Timetable: Long 	<ul style="list-style-type: none"> • Unknown risks: Class 5
Option 2	<ul style="list-style-type: none"> • Greenfield or Brownfield: Brownfield • Location (regional/distance factors): Regional • Project network element size: 10 to 100 km, no. of Bays 1-5 • Terrain: Hilly/Undulating and Mountainous • Delivery Timetable: Long 	<ul style="list-style-type: none"> • Known risks: BAU • Unknown risks: Class 5
Option 3	<ul style="list-style-type: none"> • Greenfield or Brownfield: Brownfield • Location (regional/distance factors): Regional • Project network element size: 10 to 100 km, no. of Bays 1-5 • Terrain: Hilly/Undulating and Mountainous • Delivery Timetable: Long 	<ul style="list-style-type: none"> • Known risks: BAU • Unknown risks: Class 5
Option 4	<ul style="list-style-type: none"> • Greenfield or Brownfield: Brownfield • Location (regional/distance factors): Regional • Project network element size: 10 to 100 km, no. of Bays 1-5 • Terrain: Hilly/Undulating and Mountainous • Delivery Timetable: Long 	<ul style="list-style-type: none"> • Known risks: BAU • Unknown risks: Class 5
Option 5	<ul style="list-style-type: none"> • Greenfield or Brownfield: Brownfield • Location (regional/distance factors): Regional • Project network element size: 10 to 100 km, no. of Bays 1-5 • Terrain: Hilly/Undulating and Mountainous • Delivery Timetable: Long 	<ul style="list-style-type: none"> • Known risks: BAU • Unknown risks: Class 5

† AEMO *Transmission Cost Database* estimates shown. Will be updated with Marinus Link RIT-T estimates if available.

4.6 Victoria

4.6.1 Ovens Murray (V1)

Summary				
<p>The Ovens Murray REZ has been identified as a candidate REZ due to this REZ having good pumped hydro resources. There is currently 770 MW of installed hydro generation within this zone.</p>		<p>○-○ Option 1,3 ○-○ Option 2</p>		
Existing network capability				
<p>The current network hosting capacity in Ovens Murray is approximately 300 MW.</p>				
Augmentation options				
Description	Additional network capacity (MW)	Expected cost (\$ million)	Cost classification	Lead time
<p>Option 1:</p> <ul style="list-style-type: none"> • A new double-circuit 330 kV transmission line from South Morang to Dederang to Murray. • Two 330/220 kV transformers at South Morang and Dederang. • Uprate Murray–Lower Tumut and Murray–Upper Tumut 330 kV lines. • Cut-in Rowville–South Morang 220 kV line at South Morang. • Additional reactive plants at South Morang, Dederang and Murray. 	1,500 MW	1,350	Class 5 (±30%)	Long
<p>Option 2:</p> <ul style="list-style-type: none"> • Convert South Morang–Dederang–Murray–Upper Tumut–Lower Tumut 330 kV lines to 500 kV design and operation. • Replace the existing South Morang–Dederang–Murray two 330 kV lines with new two 500 kV lines. • Replace the existing Murray–Upper Tumut, Murray–Lower Tumut, Upper Tumut–Lower Tumut 330 kV lines with single-circuit 500 kV line. • Two 500/220 kV transformers at Dederang. • Two 500/330 kV transformers at Murray. • A 500/330 kV transformer at Lower Tumut and Upper Tumut. • Additional reactive plants at South Morang, Dederang, Murray, Upper Tumut and Lower Tumut. 	1,500 MW	2,870	Class 5 (±30%)	Long

Option 3: <ul style="list-style-type: none"> • A new single-circuit 330 kV transmission line from South Morang to Dederang to Murray. • New 330/220 kV transformer at South Morang and Dederang. • Uprate Murray–Lower Tumut and Murray–Upper Tumut 330 kV lines. • Cut-in Rowville–South Morang 220 kV line at South Morang. • Additional reactive plant at South Morang, Dederang and Murray. 	1,100 MW	1,060	Class 5 (±30%)	Long
---	----------	-------	----------------	------

Adjustment factors and risk

Option	Adjustment factors applied	Known and unknown risks applied
Option 1	<ul style="list-style-type: none"> • Location for transmission line 'remote' • Land use 'grazing' • Total circuit length 'above 200 km' • Delivery timetable 'long' • Proportion of environmentally sensitive areas '50%' 	<ul style="list-style-type: none"> • Known risks: High due to potential difficulties in obtaining additional easements/land around the South Morang substation • Unknown risks: Class 5
Option 2	<ul style="list-style-type: none"> • Location for transmission line 'remote' • Land use 'grazing' • Total circuit length 'above 200 km' • Delivery timetable 'long' • Proportion of environmentally sensitive areas '50%' 	<ul style="list-style-type: none"> • Known risks: High due to potential difficulties in obtaining additional easements/land around the South Morang substation • Unknown risks: Class 5 • Outage restrictions: High
Option 3	<ul style="list-style-type: none"> • Location for transmission line 'remote' • Land use 'grazing' • Total circuit length 'above 200 km' • Delivery timetable 'long' • Proportion of environmentally sensitive areas '50%' 	<ul style="list-style-type: none"> • Known risks: High due to potential difficulties in obtaining additional easements/land around the South Morang substation • Unknown risks: Class 5

4.6.2 Murray River (V2)

Summary				
<p>The Murray River REZ has good solar resources. Despite being remote and electrically weak, this REZ has attracted significant investment in solar generation. Voltage stability and thermal limits currently restrict the output of generators within this REZ.</p> <p>The proposed VNI West project could upgrade transfer capability between Victoria and New South Wales via either Kerang or Shepparton. The development of VNI West via Kerang would significantly increase the ability for renewable generation to connect in this zone. The proposed new interconnector between New South Wales and South Australia (Project EnergyConnect) will facilitate a small improvement in capacity within Murray River REZ.</p>				
Existing network capability				
No additional capacity to connect new generation.				
Augmentation options				
Description	Additional network capacity (MW)	Expected cost (\$ million)	Cost classification	Lead time
Option 1: <ul style="list-style-type: none"> • New double-circuit 220 kV line from Red Cliffs – Wemen – Kerang – Bendigo - north of Ballarat. • New 500/220 kV 1,000 MVA transformer north of Ballarat 	1,200	1,030	Class 5 (±30%)	Long
Option 2: <ul style="list-style-type: none"> • New double-circuit 500 kV line from Kerang – Bendigo (including 2 new 500/220 kV transformers at Kerang). • Turn the 500 kV line from north of Ballarat to Shepparton into Bendigo (including new 500 kV substation near Bendigo). <i>Pre-requisite: VNI West (Shepparton)</i>	1,300	640	Class 5 (±30%)	Long
Option 3: <ul style="list-style-type: none"> • New double-circuit 500 kV line from north of Ballarat to Kerang (including 2 new 500/220 kV transformers at Kerang) 	1,000	940	Class 5 (±30%)	Long
Option 4: <ul style="list-style-type: none"> • New 220 kV double-circuit line from Red Cliffs – Wemen – Kerang 	500	500	Class 5 (±30%)	Long
Adjustment factors and risk				
Option	Adjustment factors applied	Known and unknown risks applied		
Option 1	<ul style="list-style-type: none"> • Location for transmission line 'regional' • Land use 'grazing' • Total circuit length 'above 200 km' • Delivery timetable 'long' • Proportion of environmentally sensitive areas '25%' 	<ul style="list-style-type: none"> • Known risks: BAU • Unknown risks: Class 5 		

Option 2	<ul style="list-style-type: none"> • Location for transmission line 'regional' • Land use 'grazing' • Total circuit length 'above 200 km' • Delivery timetable 'long' • Proportion of environmentally sensitive areas '25%' 	<ul style="list-style-type: none"> • Known risks: BAU • Unknown risks: Class 5
Option 3	<ul style="list-style-type: none"> • Location for transmission line 'regional' • Land use 'grazing' • Total circuit length 'above 200 km' • Delivery timetable 'long' • Proportion of environmentally sensitive areas '25%' 	<ul style="list-style-type: none"> • Known risks: BAU • Unknown risks: Class 5
Option 4	<ul style="list-style-type: none"> • Location for transmission line 'regional' • Land use 'grazing' • Total circuit length 'above 200 km' • Delivery timetable 'long' • Proportion of environmentally sensitive areas '25%' 	<ul style="list-style-type: none"> • Known risks: BAU • Unknown risks: Class 5

4.6.3 Western Victoria (V3)

Summary				
<p>The Western Victoria REZ has good to excellent quality wind resources. The existing and committed renewable generation within this REZ exceeds 1 GW, all of which is from wind generation. The current network is constrained and cannot support any further connection of renewable generation without transmission augmentation.</p> <p>The Western Victoria Transmission Network Project is a committed ISP project, with the preferred option to expand generation within this zone.</p>				
Existing network capability				
<p>Approximately 450 MW of new generation can be connected after the completion of the committed Western Victoria Transmission Network Project.</p>				
Augmentation options				
Description	Additional network capacity (MW)	Expected cost (\$ million)	Cost classification	Lead time
<p>Option 1:</p> <ul style="list-style-type: none"> Build a new single-circuit 500 kV line from Mortlake to the new 500 kV substation north of Ballarat. 	1,200	590	Class 5 (±30%)	Long
<p>Option 2:</p> <ul style="list-style-type: none"> Build a new double-circuit line from north of Ballarat to Bulgana (with one circuit turning into Ararat and Crowlands). Create additional 220 kV line from north of Ballarat to Ballarat. New 1,000 MVA 500/220 kV transformer north of Ballarat. Series reactor on Crowlands-Ararat-Bulgana circuit. 	1,000	460	Class 5 (±30%)	Long
<p>Option 3:</p> <ul style="list-style-type: none"> Convert the new 220 kV line from north of Ballarat to Bulgana (part of Western Victoria Transmission Network Project) to 500 kV. 	1,000	210	Class 5 (±30%)	Long
<p>Option 4:</p> <ul style="list-style-type: none"> New 220 kV double-circuit line from Murra Warra to Bulgana via Horsham. <p><i>Pre-requisite: V3 Option 2 or Option 3.</i></p>	1,000	300	Class 5 (±30%)	Long
<p>Option 5:</p> <ul style="list-style-type: none"> New 220 kV single-circuit line from Elaine to Moorabool. 	600	120	Class 5 (±30%)	Long
<p>Option 6:</p> <ul style="list-style-type: none"> New 500 kV double-circuit line from Bulgana to Mortlake. 	1,000	550	Class 5 (±30%)	Long
Adjustment factors and risk				
Option	Adjustment factors applied	Known and unknown risks applied		
Option 1	<ul style="list-style-type: none"> Location for transmission line 'regional' Land use 'scrub' Delivery timetable 'long' Proportion of environmentally sensitive areas '25%' 	<ul style="list-style-type: none"> Known risks: BAU Unknown risks: Class 5 		

Option 2	<ul style="list-style-type: none"> • Location for transmission line 'regional' • Land use 'scrub' • Delivery timetable 'long' • Proportion of environmentally sensitive areas '25%' 	<ul style="list-style-type: none"> • Known risks: BAU • Unknown risks: Class 5
Option 3	<ul style="list-style-type: none"> • Location for transmission line 'regional' • Land use 'scrub' • Delivery timetable 'long' • Proportion of environmentally sensitive areas '25%' 	<ul style="list-style-type: none"> • Known risks: BAU • Unknown risks: Class 5
Option 4	<ul style="list-style-type: none"> • Location for transmission line 'regional' • Land use 'scrub' • Delivery timetable 'long' • Proportion of environmentally sensitive areas '25%' 	<ul style="list-style-type: none"> • Known risks: BAU • Unknown risks: Class 5
Option 5	<ul style="list-style-type: none"> • Location for transmission line 'regional' • Land use 'scrub' • Delivery timetable 'long' • Proportion of environmentally sensitive areas '25%' 	<ul style="list-style-type: none"> • Known risks: BAU • Unknown risks: Class 5
Option 6	<ul style="list-style-type: none"> • Location for transmission line 'regional' • Land use 'scrub' • Delivery timetable 'long' • Proportion of environmentally sensitive areas '25%' 	<ul style="list-style-type: none"> • Known risks: BAU • Unknown risks: Class 5

4.6.4 South West Victoria (V4)

Summary				
<p>The South West Victoria REZ has moderate to good quality wind resource in close proximity to the 500 kV and 220 kV networks in the area.</p> <p>The total committed and in-service wind generation in the area exceeds 1.7 GW.</p>				
Existing network capability				
<p>Currently the 220 kV network is congested, however there is still approximately 750 MW of hosting capacity remaining on the 500 kV network.</p>				
Augmentation options				
Description	Additional network capacity (MW)	Expected cost (\$ million)	Cost classification	Lead time
<p>Option 1:</p> <ul style="list-style-type: none"> New 500 kV single-circuit line from Mortlake – Moorabool – Sydenham. 	1,500	710	Class 5 (±30%)	Long
<p>Option 2:</p> <ul style="list-style-type: none"> New 500 kV single-circuit line from Mortlake to north of Ballarat. Turn Tarrone – Haunted Gully line into Mortlake substation. 	1,200	510	Class 5 (±30%)	Long
Adjustment factors and risk				
Option	Adjustment factors applied	Known and unknown risks applied		
Option 1	<ul style="list-style-type: none"> Location for transmission line 'regional' Land use 'scrub' Total circuit length 'above 200 km' Delivery timetable 'long' Proportion of environmentally sensitive areas '25%' 	<ul style="list-style-type: none"> Known risks: BAU Unknown risks: Class 5 		
Option 2	<ul style="list-style-type: none"> Location for transmission line 'regional' Land use 'scrub' Delivery timetable 'long' Proportion of environmentally sensitive areas '25%' 	<ul style="list-style-type: none"> Known risks: BAU Unknown risks: Class 5 		

4.6.5 Gippsland (V5)

Summary				
<p>There is currently significant wind generation interest in this area, including a large offshore wind farm of 2,000 MW†.</p>				
Existing network capability				
<p>Due to the strong network in this REZ (with multiple 500 kV and 220 kV lines from Latrobe Valley to Melbourne designed to transport energy from major Victorian brown coal power station), significant generation can be accommodated.</p> <p>Approximately 2,000 MW of new VRE can be accommodated prior to network augmentations. Options shown extend the network further to allow for easier connection of generation.</p>				
Augmentation options				
Description	Additional network capacity (MW)	Expected cost (\$ million)	Cost classification	Lead time
<p>Option 1:</p> <ul style="list-style-type: none"> • New 500 kV double-circuit line from Hazelwood to Gippsland. • Two 500/220 kV transformers in Gippsland. 	2,500	430	Class 5 (±30%)	Long
<p>Option 2:</p> <ul style="list-style-type: none"> • New 220 kV double-circuit line from Hazelwood P.S to Gippsland. 	450	160	Class 5 (±30%)	Long
Adjustment factors and risk				
Option	Adjustment factors applied	Known and unknown risks applied		
Option 1	<ul style="list-style-type: none"> • Location for transmission line 'regional' • Land use 'scrub' • Delivery timetable 'long' • Proportion of environmentally sensitive areas '25%' 	<ul style="list-style-type: none"> • Known risks: BAU • Unknown risks: Class 5 		
Option 2	<ul style="list-style-type: none"> • Location for transmission line 'regional' • Land use 'scrub' • Delivery timetable 'long' • Proportion of environmentally sensitive areas '25%' 	<ul style="list-style-type: none"> • Known risks: BAU • Unknown risks: Class 5 		

† Geographic boundaries of this REZ under review in order to be able account for wind and solar resources and connection interest further east than the existing boundary shown.

4.6.6 Central North Vic (V6)

Summary				
<p>The Central North Victoria REZ has moderate quality wind and solar resources. In addition to the currently in service and committed solar farms, the solar generation applications exceed 200 MW whilst the enquires within this zone exceeds 2.5 GW.</p> <p>The potential VNI West project could increase transfer capability between Victoria and New South Wales via either Kerang or Shepparton. The development of VNI West via Shepparton would significantly increase the ability for renewable generation to connect in this zone.</p>				
Existing network capability				
<p>The current network hosting capacity in Central North Victoria is approximately 700 MW.</p>				
Augmentation options				
Description	Additional network capacity (MW)	Expected cost (\$ million)	Cost classification	Lead time
<p>Option 1:</p> <ul style="list-style-type: none"> New 500 kV substation near Shepparton (including two 500/220 kV transformers). New 220 kV double-circuit line from north of Ballarat - Bendigo - Shepparton. 	1,700	920	Class 5 (±30%)	Long
<p>Option 2:</p> <ul style="list-style-type: none"> New 220 kV double-circuit line from north of Ballarat - Bendigo - Shepparton. 	600	490	Class 5 (±30%)	Long
<p>Option 3:</p> <ul style="list-style-type: none"> New 220 kV double-circuit line from north of Ballarat - Bendigo - Shepparton - Glenrowan. 	800	650	Class 5 (±30%)	Long
<p>Option 4:</p> <ul style="list-style-type: none"> New 220 kV single-circuit line from Shepparton to Dederang via Glenrowan. 	800	350	Class 5 (±30%)	Long
<p>Option 5:</p> <ul style="list-style-type: none"> New 220 kV double-circuit line from Bendigo to Shepparton. 	800	300	Class 5 (±30%)	Long
Adjustment factors and risk				
Option	Adjustment factors applied	Known and unknown risks applied		
Option 1	<ul style="list-style-type: none"> Location for transmission line 'regional' Total circuit length 'above 200 km' Delivery timetable 'long' Proportion of environmentally sensitive areas '25%' 	<ul style="list-style-type: none"> Known risks: BAU Unknown risks: Class 5 		

Option 2	<ul style="list-style-type: none"> • Location for transmission line 'regional' • Total circuit length 'above 200 km' • Delivery timetable 'long' • Proportion of environmentally sensitive areas '25%' 	<ul style="list-style-type: none"> • Known risks: BAU • Unknown risks: Class 5
Option 3	<ul style="list-style-type: none"> • Location for transmission line 'regional' • Land use 'scrub' • Total circuit length 'above 200 km' • Delivery timetable 'long' • Proportion of environmentally sensitive areas '25%' 	<ul style="list-style-type: none"> • Known risks: BAU • Unknown risks: Class 5
Option 4	<ul style="list-style-type: none"> • Location for transmission line 'regional' • Land use 'scrub' • Delivery timetable 'long' • Proportion of environmentally sensitive areas '25%' 	<ul style="list-style-type: none"> • Known risks: BAU • Unknown risks: Class 5
Option 5	<ul style="list-style-type: none"> • Location for transmission line 'regional' • Land use 'scrub' • Delivery timetable 'long' • Proportion of environmentally sensitive areas '25%' 	<ul style="list-style-type: none"> • Known risks: BAU • Unknown risks: Class 5

5. Generator connection costs

This chapter outlines the costs associated with the connection new generators to the network. Generator connection costs describe the network elements required to physically connect to the wider network as well as any system strength remediation costs where applicable.

Figure 10 illustrates how connection costs are defined in relation to the REZ network expansion costs.

Figure 10 Connection cost representation

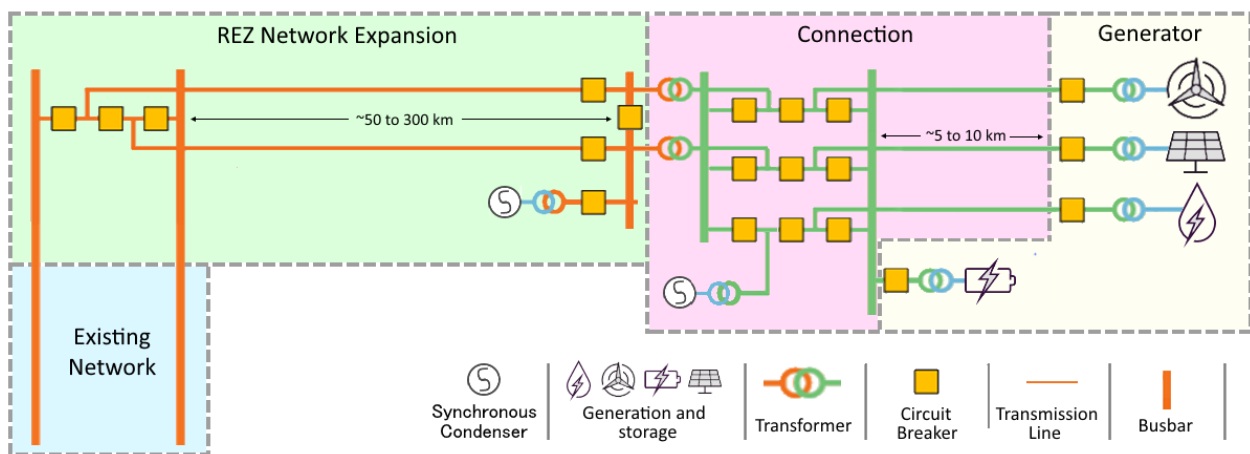

5.1 Connection costs

Connection costs are added to generator costs to account for the transmission infrastructure required to connect a generator within a REZ to the REZ network. The connection costs vary depending on the proximity to transmission assets and the voltage of the network.

The proximity of the generation to the transmission network is assumed to vary depending on the generator technology. Due to resource location, wind, solar, and pumped hydro projects will often be located 5-10 km from the existing network. The connection cost of battery storage is lower than other storage and generation options because battery storage has more flexibility in its location and can leverage the connection assets used in connecting VRE.

Table 9 describes the parameters of the connection assets used for solar, wind, and solar thermal generation connecting in each REZ, and Table 10 describes parameters for other generation technologies which are close to the network. Table 11 describes parameters for batteries which require no feeder.

Table 9 Connection costs for solar, wind, and solar thermal generation technologies

REZ names	Region	REZ network voltage (kV)	Connection capacity (MVA)	Feeder length (km)	Feeder numbers	Total cost (\$M)
Far North Queensland	QLD	275	300	5	2	33
North Queensland Clean Energy Hub	QLD	275	300	10	2	40
North Queensland	QLD	275	300	5	2	33
Isaac	QLD	275	300	5	2	33
Barcaldine	QLD	275	300	10	2	40
Fitzroy	QLD	275	300	5	2	33
Wide Bay	QLD	275	300	5	2	33
Darling Downs	QLD	275	300	5	2	33
Banana	QLD	275	300	5	2	33
North West New South Wales	NSW	330	400	10	3	57
New England	NSW	330	400	10	3	57
Central West New South Wales	NSW	330	400	10	3	57
Cooma-Monaro	NSW	330	400	5	3	43
Wagga Wagga	NSW	330	400	10	3	57
Tumut	NSW	330	400	5	3	43
South West New South Wales	NSW	330	400	10	3	57
Broken Hill	NSW	220	250	10	2	40
Murray River	VIC	220	250	5	2	33
Western Victoria	VIC	220	250	5	2	33
South West Victoria	VIC	500	600	10	2	57
Ovens Murray	VIC	220	250	5	2	33
Gippsland	VIC	220	250	10	2	40
Central North Victoria	VIC	220	250	10	2	40
South-East SA	SA	275	300	10	2	40
Riverland	SA	275	300	10	2	40
Mid-North SA	SA	275	300	5	2	33
Yorke Peninsula	SA	275	300	5	2	33
Northern SA	SA	275	300	5	2	33
Leigh Creek	SA	275	300	10	2	40
Roxby Downs	SA	275	300	10	2	40

REZ names	Region	REZ network voltage (kV)	Connection capacity (MVA)	Feeder length (km)	Feeder numbers	Total cost (\$M)
Eastern Eyre Peninsula	SA	275	300	10	2	40
Western Eyre Peninsula	SA	275	300	10	2	40
North-West Tasmania	TAS	220	150	5	1	27
Central Highlands	TAS	220	150	5	1	27
North-East Tasmania	TAS	220	150	5	1	27
Adjustment factors and risk						
Option	Adjustment factors applied		Known and unknown risks applied			
All options	<ul style="list-style-type: none"> Location (regional/distance factors): Regional Project network element size: no. of total Bays 1-5 		Known risks: BAU Unknown risks: Class 5			

Table 10 Connection costs for other generation technologies (excluding batteries)†

Connection voltage (kV)	Connection capacity (MVA)	Feeder length (km)	Feeder numbers	Total cost (\$M)
500	600	1	3	40
330	400	1	2	28
275	300	1	2	28
220	250	1	2	24
Adjustment factors and risk				
Option	Adjustment factors applied		Known and unknown risks applied	
All options	<ul style="list-style-type: none"> Project network element size: no. of total Bays 1-5, 1 to 5 km 		<ul style="list-style-type: none"> Known risks: BAU Unknown risks: Class 5 	

† Connection costs for pumped hydro and offshore wind are included in the generation cost.

Table 11 Connection costs for batteries

Connection voltage (kV)	Connection capacity (MVA)	Total cost (\$M)
500	600	36
330	400	25
275	300	25
220	250	22
Adjustment factors and risk		
Option	Adjustment factors applied	Known and unknown risks applied
All options	<ul style="list-style-type: none"> Project network element size: no. of total Bays 1-5 	<ul style="list-style-type: none"> Known risks: BAU Unknown risks: Class 5

5.2 System strength remediation costs

System strength remediation is a complex requirement that is dependent on synchronous generation dispatch, network upgrades, and the scale of local inverter-based resources (IBR). As such, any remediation requirements not already built into network upgrade costs are post-processed. Section 4.2.4 of AEMO's *Draft ISP Methodology*²⁰ provides an overview of the fault level calculation methods used to derive system strength mitigation requirements.

Synchronous condenser costs are used to derive a proxy cost for potential system strength remediation solutions. Costs shown include synchronous condensers, site works and buildings, step up transformers, and high voltage connection assets. The addition of flywheels for high-inertia synchronous condensers incurs an additional \$2 million cost.

Table 12 System strength remediation options

System strength remediation options			
Description	Expected cost (\$ million)	Cost classification	Lead time
• 80 MVA synchronous condenser	50	Class 5 (±30%)	Medium
• 125 MVA synchronous condenser	65	Class 5 (±30%)	Medium
• 250 MVA synchronous condenser	125	Class 5 (±30%)	Medium
Adjustment factors and risk			
Option	Adjustment factors applied	Known and unknown risks applied	
All options	<ul style="list-style-type: none"> Greenfield or Brownfield: Partly Brownfield Location (regional/distance factors): Regional Project network element size: no. of total Bays 1-5 	<ul style="list-style-type: none"> Known risks: Project Complexity was judged as partly complex due to the level of detailed studies required. Unknown risks: Class 5 	

Based on 2020 ISP studies, system strength remediation for the Step Change Scenario (see ISP Appendix 5²¹) calculated a need for 15 125 MVA synchronous condensers, and 17 250 MVA synchronous condensers, to cater for 33 GW of new renewables across the NEM. Using the updated *Transmission Cost Database*, this translates to an additional \$0.088 million/MW if included in REZ expansion costs, or \$88/kW if included in generator connection costs. The process to account for system strength costs is outlined in the *Draft ISP Methodology*²².

The breakdown of which REZs have system strength remediation costs allocated to REZ expansion cost or generator connection costs is shown in the draft IASR²³.

²⁰ AEMO. *Consultation on the ISP Methodology*, available at <https://aemo.com.au/en/consultations/current-and-closed-consultations/isp-methodology>.

²¹ AEMO, *ISP Appendix 5*, at: <https://aemo.com.au/-/media/files/major-publications/isp/2020/appendix--5.pdf>.

²² AEMO. *Consultation on the ISP Methodology*, available at <https://aemo.com.au/en/consultations/current-and-closed-consultations/isp-methodology>.

²³ AEMO. *DRAFT 2021 Inputs Assumptions and Scenario Report*, at: https://aemo.com.au/-/media/files/electricity/nem/planning_and_forecasting/inputs-assumptions-methodologies/2021/draft-2021-inputs-assumptions-and-scenarios-report.pdf.

A1. Cost classification checklist

The checklist developed by AEMO for review of the TNSP estimates is shown below.

	Class 5	Class 4	Class 3	Class 2/1
Scope of works – line, station, cable				
Voltage defined?	Yes	Yes	Yes	Yes
Rating (MVA, MW, MVA _r) defined?	Yes	Yes	Yes	Yes
Conductors specified?	Yes	Yes	Yes	Yes
Connection locations (substation, terminal station, converter) defined?	Yes	Yes	Yes	Yes
Which option best describes the maturity of the routing?	Preliminary Corridor	High Level Route	Detailed Route	Detailed Route
Has gas network avoidance measures been included?	No	No	Yes	Yes
Which option best describes the consideration of national parks?	None	High Level	Detailed	Detailed
Which option best describes the consideration of cultural heritage?	High Level	High Level	Detailed	Detailed
Which option best describes the consideration of environmentally sensitive areas?	High Level	High Level	Detailed	Detailed
Underground lines defined?	No	No	Yes	Yes
Which option best describes the maturity of the design?	Concept/High Level	Preliminary	Detailed/Complete	Detailed/Complete
Which option best describes the documentation prepared?	Conceptual Single Line Diagram	Detailed Single Diagram	For Construction/Civil Diagrams	For Construction/Civil Diagrams

	Class 5	Class 4	Class 3	Class 2/1
Level of site investigation for stations/substations/converters/terminal stations?	Desktop	Desktop	Preliminary Site Investigation	Detailed Investigation
Has site remoteness been incorporated into the scope of works?	Yes	Yes	Yes	Yes
Which option best describes the geographical location of any stations/substations included?	Assumed	General Area Defined	Actual Location Defined	Actual Location Defined
Which option best describes the tower design progress?	Assumption Based	Preliminary Design	Final Design	Final Design
Sites				
Are there any environmental offsets included based on past experience?	Yes	Yes	Yes	Yes
Strategy/approach developed to refine environmental offsets complete?	Yes	Yes	Yes	Yes
Are outage restrictions (specific to line diversions and cut ins) considered?	No	No	Yes	Yes
Which option best describes the consideration of brownfield works across the project?	None	Indicative	Indicative	Detailed/Complete
Terrain assessment	Desktop	Detailed	Detailed	Detailed
Which option best describes the current level of engagement with landowners?	None	None	Community Level	Landowner Level
Project management and delivery				
Which option best describes the level of geotech assessment?	None	None	Desktop Assessment	Detailed Assessment
Which option best describes the source of cost estimate for equipment and construction?	Previous Projects	Single In-house Price	Multiple Quotes	Fixed Contract
Which option best describes the identification and assessment of risk progress?	Concept/High Level	Preliminary	Preliminary	Detailed/Complete
Has macroeconomic influence been factored into the assessment of risk?	Yes	Yes	Yes	Yes
Has market activity been factored into the assessment of risk?	Yes	Yes	Yes	Yes
Has project complexity been factored into the assessment of risk?	Yes	Yes	Yes	Yes
Has compulsory acquisition been factored into the assessment of risk?	Yes	Yes	Yes	Yes

	Class 5	Class 4	Class 3	Class 2/1
Has environmental offset been factored into the assessment of risk?	Yes	Yes	Yes	Yes
Has geotechnical findings been factored into the assessment of risk?	Yes	Yes	Yes	Yes
Has outage restrictions been factored into the assessment of risk?	Yes	Yes	Yes	Yes
Has weather delays been factored into the assessment of risk?	Yes	Yes	Yes	Yes
Has cultural heritage been factored into the assessment of risk?	Yes	Yes	Yes	Yes
Has any allowance been made for unknown scope and technology risk?	Yes	Yes	Yes	Yes
If yes, please indicate allowance amount as a % of baseline cost				
Has any allowance been made for unknown productivity and labour cost risk?	Yes	Yes	Yes	Yes
If yes, please indicate allowance amount as a % of baseline cost				
Has any allowance been made for unknown plant procurement cost risk?	Yes	Yes	Yes	Yes
If yes, please indicate allowance amount as a % of baseline cost				
Has any allowance been made for unknown project overhead risk?	Yes	Yes	Yes	Yes
If yes, please indicate allowance amount as a % of baseline cost				
Which best describes the level of market engagement?	None	Revenue Reset/Project Brief	Pre-Tender	Tender
Regulatory				
Scope of works prepared as part of which regulatory gateway?	Future ISP	PADR	CPA	-
Regulatory model	Conventional RIT-T	Conventional RIT-T	Conventional RIT-T	Conventional RIT-T