

System Strength Framework - Overview

June 2023



We acknowledge the Traditional Owners of country throughout Australia and recognise their continuing connection to land, waters and culture.

We pay respect to their Elders past, present and emerging.

Webinar recording

- This webinar will be recorded by AEMO and may be accessed and available for use by AEMO stakeholders who have not been able to attend the session live.
- By attending the meeting, you consent to AEMO recording the meeting and using the record for this purpose.
- No other recording of the meeting is permitted.

Agenda

- The New Framework (10 min)
 - Definitions | Evolution | Intent | Structure
- Planning & Network Investment (10 min)
 - Nodes | Minimums | Efficient Levels | Stable Waveforms | RIT-Ts | SSUP
- Connections & Impact Assessment (30 min)
 - Process | System Impact | Locational Factors | SSC | Self-Rem
- Questions (40 min)
 - www.menti.com - use code 6460 1080

Introduction

Merryn York

Executive General Manager - System Design

System Strength & The New Framework

System Security Planning

What is system strength?

System strength is the ability of the power system to maintain and control the voltage waveform at any given location, both during steady state operation and following a disturbance.

System strength can partly be represented by the amount of electrical current available when there is a disturbance on the system – the fault current, but other electrical parameters are also important.

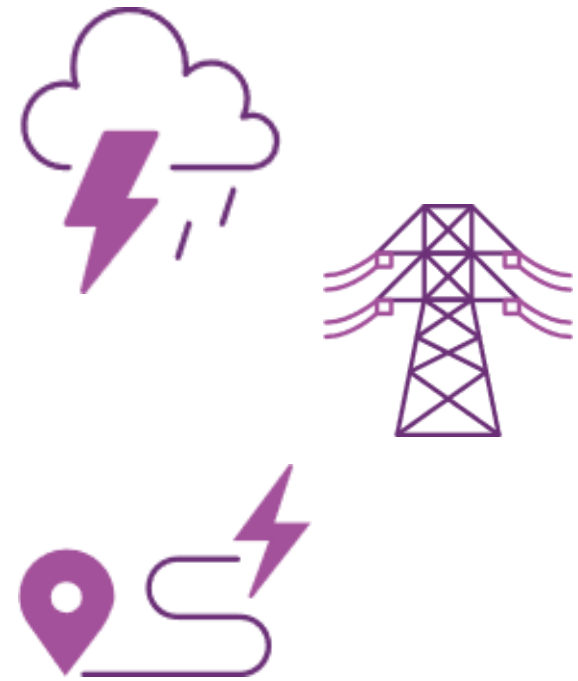

Framework has evolved over time

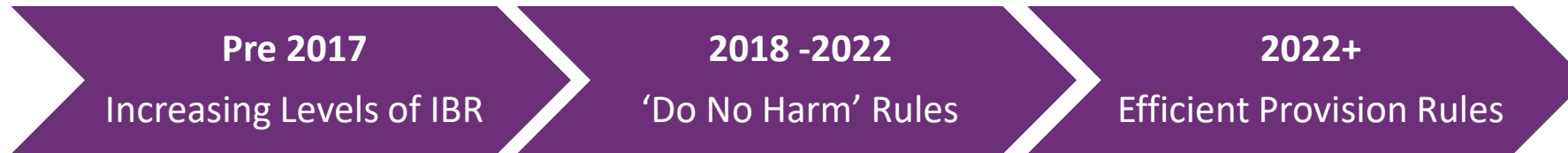

Latest changes impact both planning and connection processes:

Planning

- New power system standard **from 1 December 2022**:
 - A minimum fault level requirement (MVA).
 - An efficient level of IBR to be accommodated (MW).
- The System Strength Service Provider (TNSP/JPB) must plan to meet the new standard **from 2 December 2025**.

Connections

- New minimum access standards for generators, loads and market network service providers **from 15 March 2023**.
- Revised system strength connection options with a new charging mechanism **from 15 March 2023**.

Implementation has two parallel components

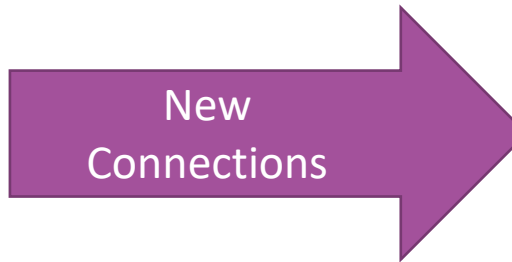

System Strength Requirements

- Strength nodes selection
- Minimum fault level methodology
- Critical planned outages
- Definition of stable voltage waveforms
- IBR forecasting approach

System Strength Impact Assessment

- System strength impact assessments
- Available fault level calculations
- System strength location factors
- Short circuit ratio assessments
- Classification criteria for inverter-based load and large IBR
- Verifying plant stability

System Strength Planning & Investment



System Security Planning

Core elements of the Planning Framework

- **September 2022** - Requirements Methodology
 - Setting out how AEMO will determine the system strength requirements and the locations at which they apply.
- **December 2022** – Requirements themselves
 - Applying the methodology to produce minimum fault level requirements and efficient levels of inverter-based resources to be accommodated.
- *Subsequently, obligations placed on the System Strength Service Providers to assess and invest.*

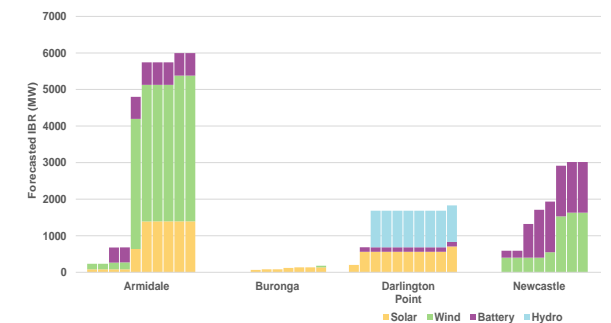

Specifying the system strength standard

Efficient IBR requirement (MW)

Ensure stable voltage waveforms such that an efficient amount of IBR can connect and remain stable during steady state conditions and following credible contingency events.

Minimum fault level requirement (MVA)

Ensure there are sufficient fault levels to enable network protection systems and voltage control devices to operate correctly.

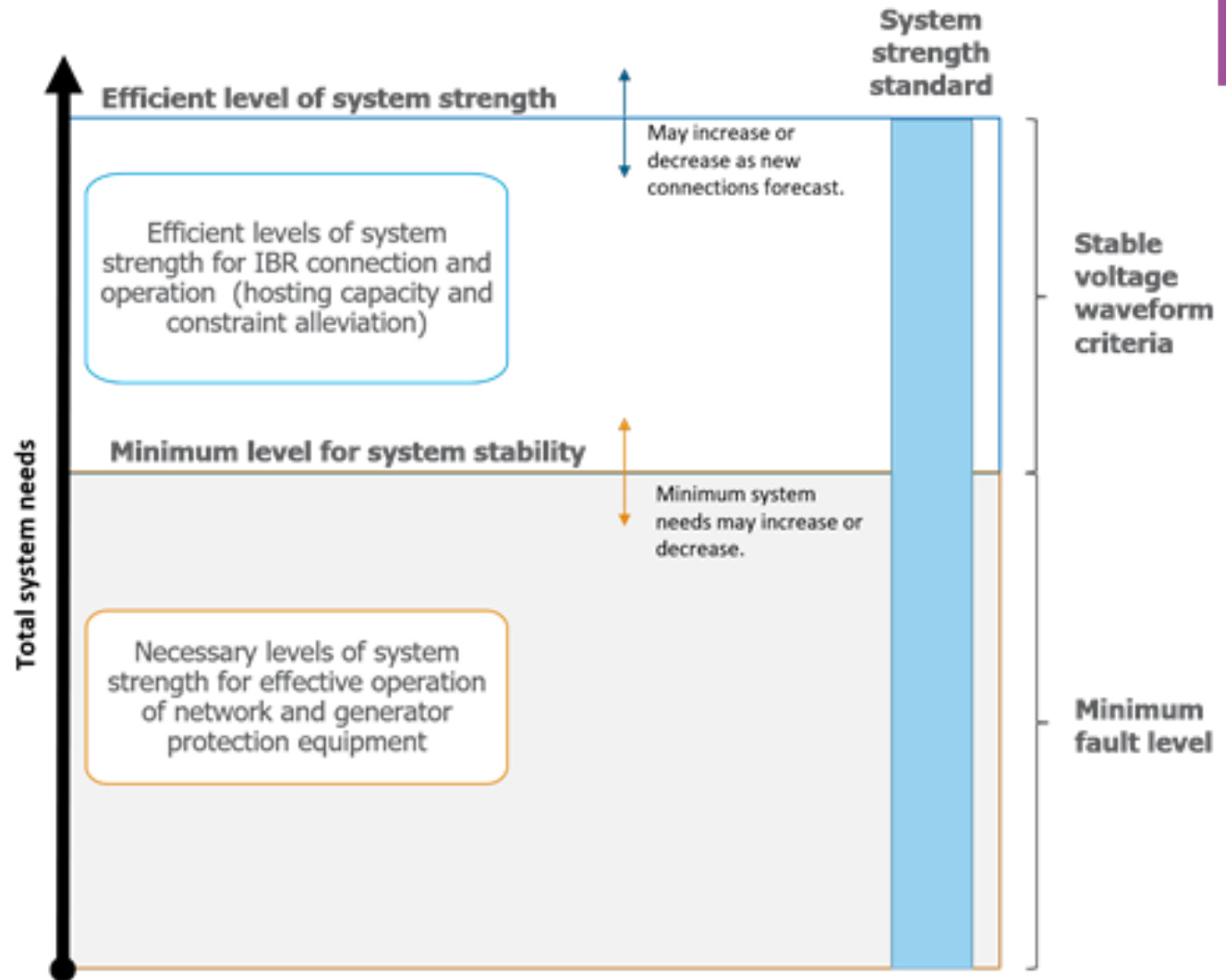

Minimum fault level requirements

- AEMO sets minimum three phase fault level requirements for each system strength node.
- For new nodes:
 - Assess protection system needs.
 - Assess voltage control system needs.
 - Assess power system stability needs.
- For existing nodes:
 - Recalculate if there has been a material change.
 - Effectively a requirement to prevent the current system from degrading over time.
- Reliance on this standard expected to reduce as efficient level requirements increase over time.
- **System Strength Service Providers:** need to plan their networks and deliver services to meet these requirements in full.

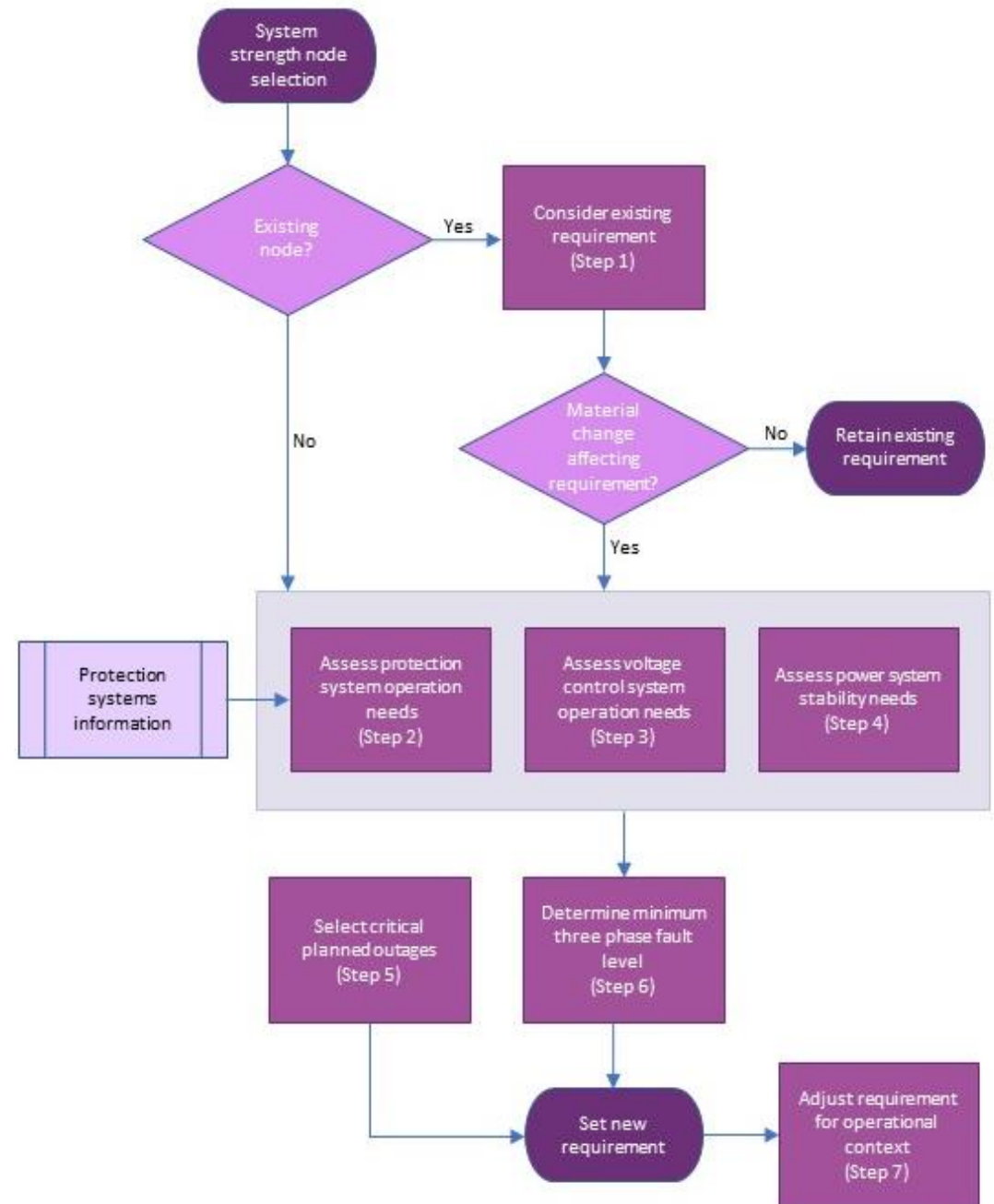

Efficient Level of IBR

- The efficient forecast of IBR is generally based on **optimal development plan**, under the **‘most likely’ scenario**, and from the **most recently published** Integrated System Plan (draft or final).
- Results are then expressed by technology, location (node), volume (MW), and timing (year).

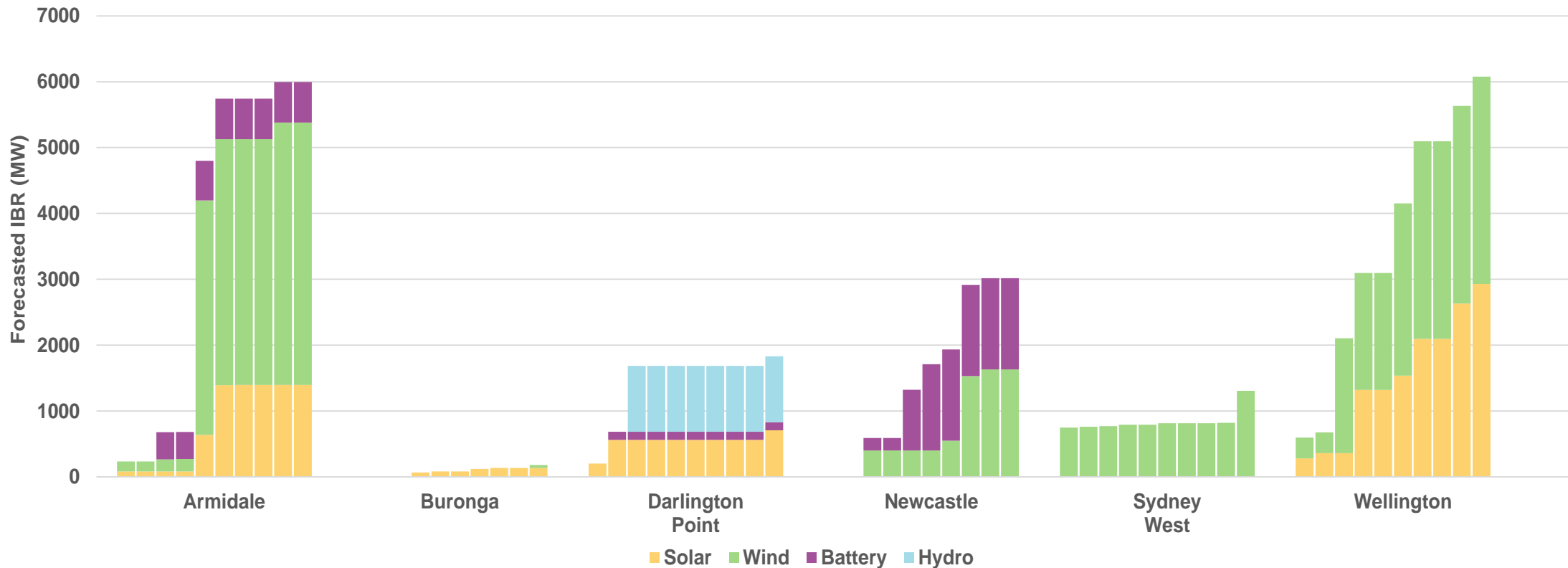

SSSPs now starting regulatory investment tests

- An SSSP is allocated for each region (the local TNSP or Jurisdictional Planning Body).
- Each SSSP must meet the new requirements by **2 December 2025**.
- The SSSP must ensure both the minimum and efficient levels of system strength are met.
- Investment is subject to a “reliability corrective” RIT-T, using a least cost approach, and an assessment of non-network options.
- SSSPs are commencing these activities.

SSSPs have published first set of unit prices

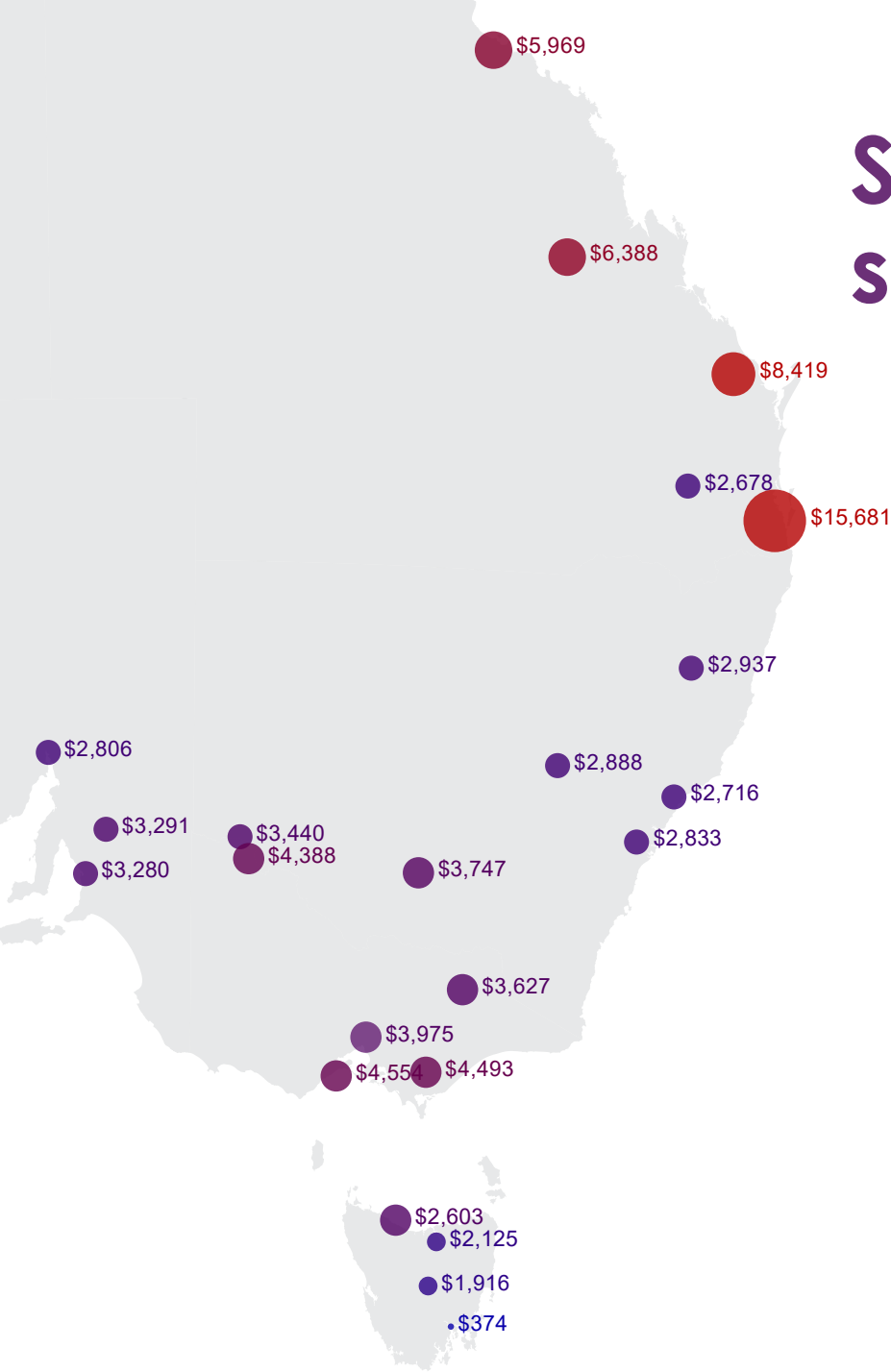

- SSSPs published Unit Prices in March 2023, which represent the cost of delivering system strength at each node.
- Charges represent the unit cost of delivering the system strength at each node.
- Connecting parties can elect to pay these charges for access to centralised services as part of their own remediation.
- Calculations consider the sharing of support between neighbouring nodes, and pricing differences are driven by:
 - Local network conditions (and effectiveness of sharing)
 - Expected hosting capacity at each node.
 - Other commercial factors (such as regional spot prices which may factor into estimated loss costs for 3rd party or non-network solutions).
- The relative benefit of the charge versus self-remediation is dependent on the needs of each.

System Strength Impact Assessment Guidelines (SSIAG)



Onboarding and Connections

AEMC Objective and Key Changes

“Facilitate more efficient and timely provision of system strength for the NEM”

Key changes:

- Definition of impact amended to "general system strength impact" = adverse system strength impact + reduction in available fault level at connection point
- Provide an option to applicants if general system strength impact found:
 - connecting plant to self remediate (currently available for the adverse impact, but not remediating a reduction in fault levels), or
 - pay NSP to remediate through system strength connection works, or
 - pay system strength charge to the System Strength Service Provider to remediate impact (new requirement)
- New minimum access standard (S5.2.5.15) requiring relevant plant to remain connected and operate stably at a Short Circuit Ratio (SCR) of 3.0
- IBLs and LIBLs are now also captured for system strength requirements in 5.3.4.B

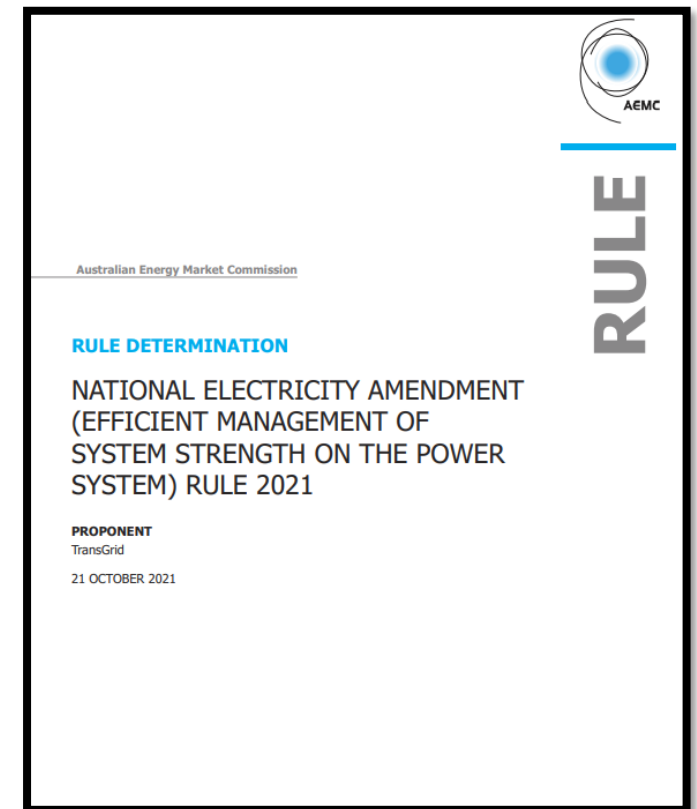

System Strength Charge vs Self Remediation

System Strength Charge

$$SSC = SSUP \times SSL \times SSQ$$

- SSUP – **System Strength Unit Price** calculated by the system strength provider
- SSL – **System Strength Locational Factor** is the relative electrical distance from closest node

$$\begin{aligned} SSLF &= 1.0 + |Z_{distance\ from\ SSN}| \\ &= 1.0 + |Z@4.6.6\ Connection - Z@SSN| \end{aligned}$$

- SSQ – **System Strength Quantity** is the expected consumption of service by the connecting party.

NER 6A.23.5(j) definition:

$$SSQ = SCR \times Prated$$

Self Remediation

$$\Delta AFL(MVA) = (-SCR_{withstand} + \alpha) \times P_{rated}$$

- $SCR_{withstand}$ - withstand SCR, assumed to be 3.0 if there is no model, or lower if demonstrated in PSCAD SMIB studies
- α – **stability coefficient** equal to 1.2
- P_{rated} – **Rated active power**, power transfer capability or maximum demand at connection point

The stability co-efficient (α) is given a value of 1.2 based on:

- Technical literature indicates minimum SCR for which voltage stability can be maintained is approximately 1.2.
- Existing NEM connections found that ~1.2 corresponds to the lowest SCR withstand capability for grid-following inverters

Issue with SSQ Calculation in the Rules

- Applying the formula for system strength quantity (SSQ) in NER 6A.23.5 could significantly **overstate the quantity of system strength required** for a connection.
- NER 6A.23.5(j) defines SSQ as the product of Short Circuit Ratio and Rated Active Power:

$$SSQ = SCR_{withstand} \times P_{rated}$$

- However, relying on an indicative withstand SCR for these quantity calculations **does not account for non-linear behavior and other network limitations** – including thermal and voltage stability limits.

Proposed improvement

- AEMO considers that the calculation of SSQ should be adjusted by a stability coefficient to better reflect the system strength required to support a connection:

$$SSQ = (SCR_{withstand}^{-\alpha}) \times P_{rated}$$

Where α is 1.2

- Aligns with intended outcomes of framework to provide efficient system strength.
- Approach is already used for the calculation of Δ AFL, however SSQ applies under unit-pricing approach. This would equate the SSQ for a connection with its Δ AFL.

SSQ guidance

- On 11 May, [AEMO published additional guidance](#) alongside the SSIAG that proposes this revised methodology for calculating SSQ.
- AEMO has been in [discussions with AER and AEMC](#) on this matter, and they are across publication of the guidance paper.
- [AEMO intends to progress a Rule change shortly to address the discrepancy.](#)

Minor SSIAG amendment

- AEMO published SSIAG V2.1 on 6 June.
- Minor change to the Δ AFL formula in SSIAG, to replace the SSQ term with $SCR_{withstand} \times P_{rated}$.

$$\Delta AFL(MVA) = -(SCR_{withstand} - \alpha) \times P_{rated}$$

Worked Example - 1

Project 1: 150 MW Wind Farm

Assumptions

- No adverse system strength impact
- Wind farm uses grid-following technology
- The Connecting NSP has calculated an SSLF of 1.1
- The plant is determined to have a $SCR_{withstand}$ of 2.5

Using these assumptions and the methodologies detailed in these Guidelines will result in the following outcomes:

| System Strength Charge Option | Self – Remediation Option |
|--------------------------------------------------------------------------------------------------|-----------------------------------------------------------------------------------------------------------------------------------------------------------------------------------------------------------------------------------------------------------------------------|
| $SSQ = SCR_{withstand} \times P_{rated} = 2.5 \times 150 = 375 \text{ MVA}$ | $\Delta AFL = (-SCR_{withstand} + \alpha) \times P_{rated}$ |
| $SSC = SSUP \times SSL \times SSQ = SSUP \times 1.1 \times 375$ $= SSUP \times 412.5$ | $= (-2.5 + 1.2) \times 150 = -195 \text{ MVA}$ |
| Modified SSQ calculation: | ΔAFL can be reduced to zero by reducing plants combined Withstand SCR to 1.2 or lower through remediation. This remediation when combined with the existing plant should achieve both the required Withstand SCR and demonstrate no adverse system strength impact. |
| $SSQ = (SCR_{withstand} - 1.2) \times P_{rated}$ $= (2.5 - 1.2) \times 150 = 195 \text{ MVA}$ | |

Worked Example - 2

Project 2: 50 MW Solar Farm + 200 MVA Grid-Forming BESS

Assumptions

- No adverse system strength impact
- Proponent has opted to self-remediate
- BESS uses grid-forming technology, solar farm uses grid-following technology
- The combined plant is determined to have a $SCR_{withstand} = 1.1$
- The maximum capacity at the connection point is 150MW

Using these assumptions, and the methodologies detailed in these Guidelines will result in the following outcomes:

$$\begin{aligned}\Delta AFL &= (-SCR_{withstand} + \alpha) \times Prated \\ &= (-1.1 + 1.2) \times 150 = 15 \text{ MVA}\end{aligned}$$

Conclusion:

- No general system strength impact
- No self-remediation required

Overview of Connection Process

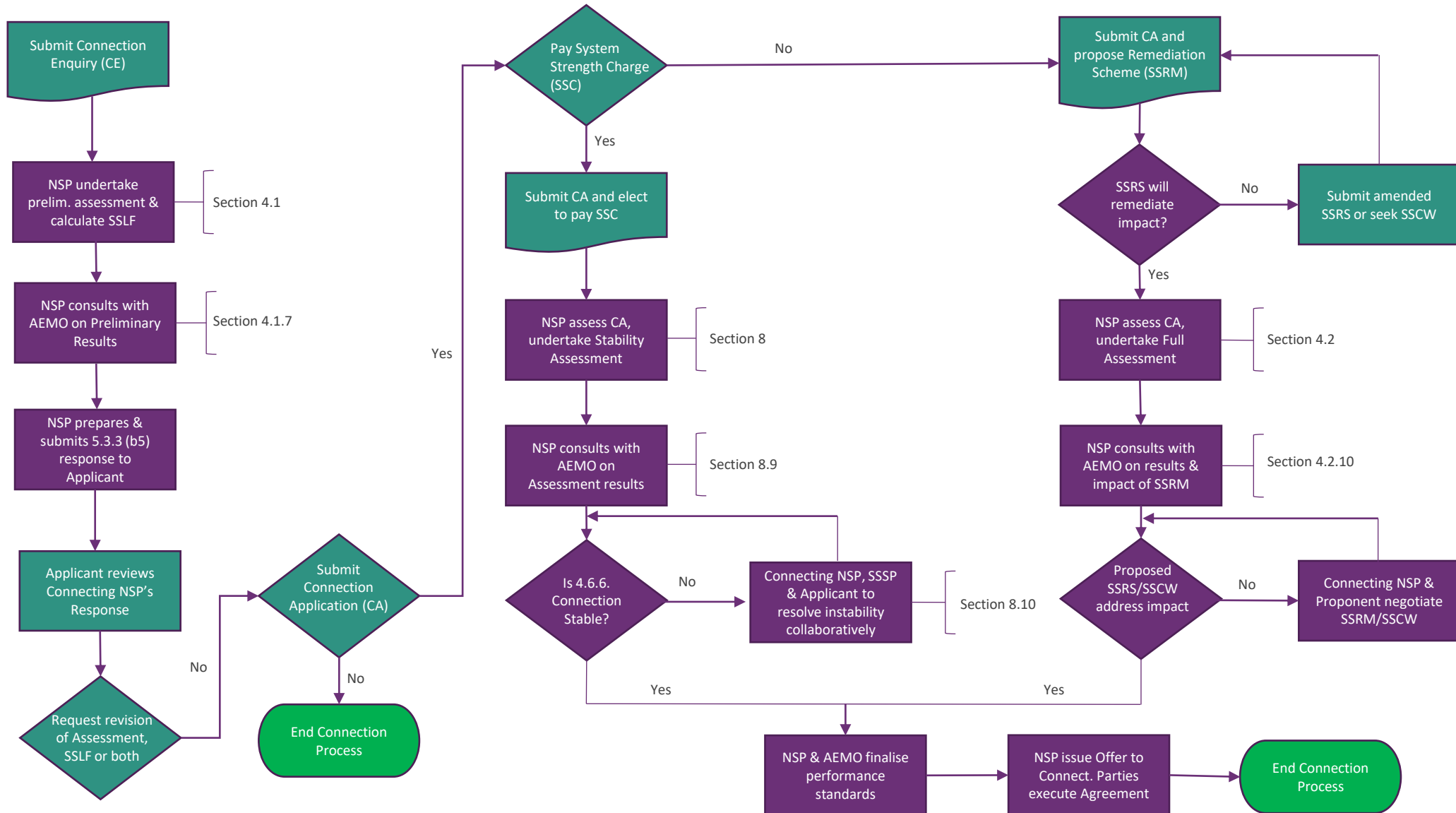

Materiality Threshold

- A general system strength impact may be disregarded if either:
 - the Preliminary Assessment determines that the **SSLF cannot be reasonably calculated** or would be manifestly excessive; or
 - the Preliminary Assessment determines that the reduction in **AFL is less than 5% of the existing AFL** at the connection point i.e. $\frac{\Delta AFL}{\text{Existing AFL}} < 5\%$
- On the condition that:
 - the Preliminary Assessment or (where this cannot be determined with confidence in the Preliminary Assessment) the Full Assessment demonstrates that the 4.6.6 Connection has **no adverse system strength impact**.
 - the Connecting NSP is satisfied the general system strength impact of the 4.6.6 Connection (by itself or combined with other anticipated connections or alterations) is not otherwise material, having regard to all relevant circumstances.

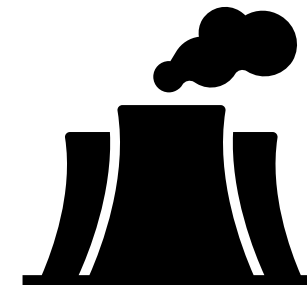
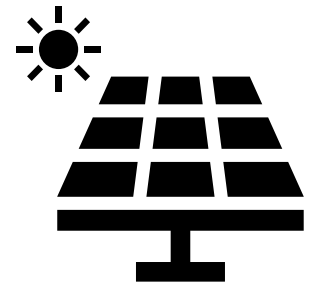
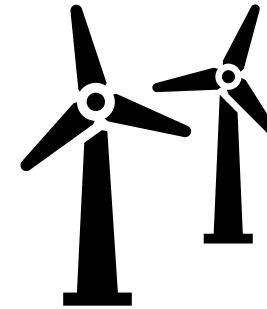

Plant Alteration

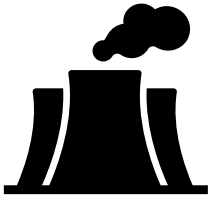

Alterations to generating system (NER 5.3.9)

- Proposed alteration must include the Applicant's proposed SSRS or an election to pay the SSC 'where relevant' i.e. in AEMO's reasonable opinion, the alteration will have a *general system strength impact* (NER 5.3.9(a)(2)).
- If AEMO determines that the alteration is likely to have a *general system strength impact*, then the rest of the process is identical to the New Connections Framework (i.e. Full Assessment or Stability assessment).
- Only assess the system strength impact of the proposed alteration.



Alterations to other plant (NER 5.3.12)

- Only applies if the proposed alteration will affect plant performance relative to S5.3.11 or S5.3a.7 (i.e. Withstand SCR capability).
- If Withstand SCR performance is affected, a Preliminary Assessment should be requested to inform SSRS or election to pay SSC.
- If Withstand SCR performance is NOT affected, NER 5.3.12 does not apply.

Forecasting Available Fault Level

Methodology – Worked example of AFL calculation for busbar#1

Step 1: Apply power system topology and configuration consistent with SSRM and the outcomes of the most recent System Strength Report.

Step 2: Calculate the Synchronous Three Phase Fault Level at busbar #1

- G1 contribution = $100 \text{ MVA} / (0.25 + 0.15) = 216 \text{ MVA}$
- G2 Contribution = $100 \text{ MVA} / 0.2 = 500 \text{ MVA}$
- Total Synchronous Three Phase Fault level @ busbar #1 = 716 MVA

Step 3: Calculate the total three phase fault level at each SSN

- IBR represented by Thevenin voltage source behind proxy impedance e.g.

$$Z_{AFL_{IBR1}} = \left| \frac{1}{\Delta AFL_{IBR1}} \right|_{S_{base}=100 \text{ MVA}} = \frac{1}{300 \text{ MVA} / 100 \text{ MVA}} = 0.3333 \text{ p. u.}$$

- Total proxy fault level at busbar #1 = 878 MVA

Step 4: Subtract fault levels calculated in Step 3 and Step 2.

- Delta Coefficient (Δ) = $878 \text{ MVA} - 716 \text{ MVA} = 162 \text{ MVA}$

Step 5: Subtract Step 4 from the Step 2. This is the AFL at the SSN.

- AFL at busbar #1 = $716 \text{ MVA} - 162 \text{ MVA} = 554 \text{ MVA}$
- This process can be repeated for all the nodes

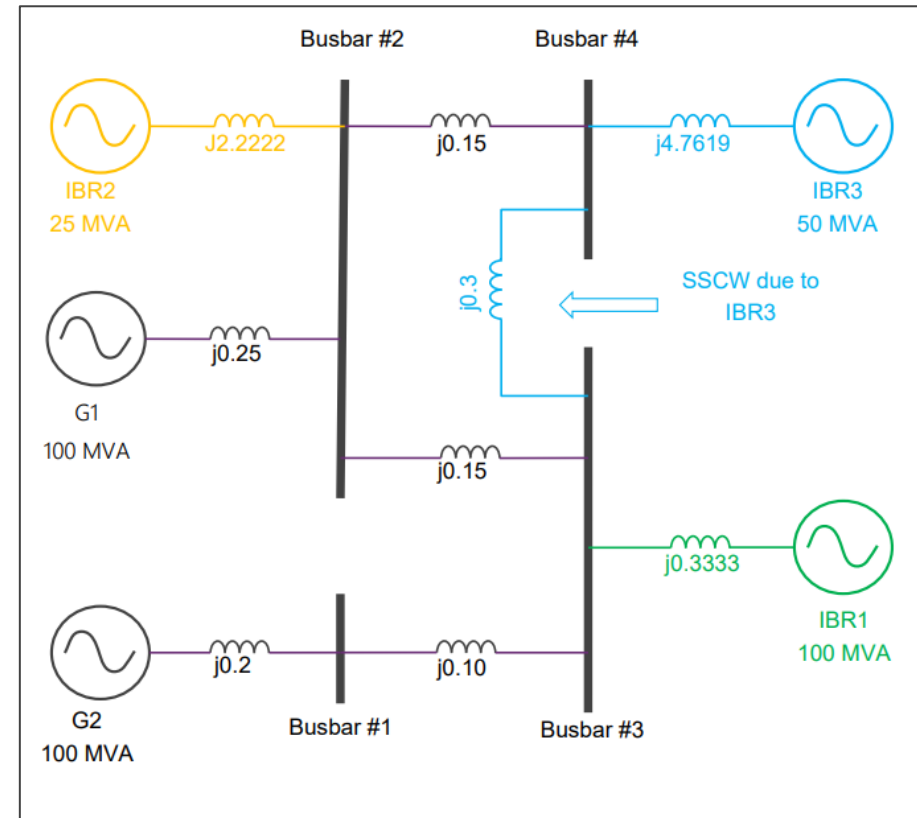

Other matters

Grid-forming inverters

- **Synchronous Three Phase Fault Level** - the three phase fault level comprising Synchronous Machines and those grid-forming inverters whose positive system strength contribution has been demonstrated by wide-area PSCAD™/EMTDC™ studies, in MVA.
- Defining methodology by which to determine positive system strength contribution of grid-forming inverters falls under TNSPs planning responsibilities.
- **Withstand SCR** – it is expected that SMIB modelling (as described in SSIAG Section 7.4) will be used to confirm Withstand SCR for generating systems that incorporate grid-forming inverters (including grid-forming BESS and hybrid systems).

Inverter Based Load (IBL)

- Loads supplied by power electronics, including inverters, and potentially susceptible to inverter control instability. However, technical capability and requirements for IBL not yet well defined.
- Further consideration will be given to including criteria what is, or is not, 'potentially susceptible' as informed by AEMO's ongoing reviews of Power System Model Guidelines and Technical Requirements for Connection (access standards).

Useful links and resources

Webpages:

- [System Strength Requirements Methodology and System Strength Impact Assessment Guidelines amendments consultation](#)
- [System Security Planning](#)
- [System Strength Impact Assessment Guidelines](#)
- [Connections in Low System Strength Zones](#)

Documents:

- [System Strength Requirements Methodology v2.0](#)
- [System Strength Impact Assessment Guidelines v2.1](#)

AEMO is also preparing a Frequently Asked Questions document that will incorporate additional questions from this webinar where relevant, and will be published on the SSIAG website in the coming weeks.



For more information visit

aemo.com.au